

MATERIAL HANDLING CATALOG

Save
40%
Instantly!

BOLTLESS SHELVING

pages 2-5



CHROME WIRE SHELVING

pages 14-15

FASTRAK BULK STORAGE SHELVING

pages 6-11



SEE PAGES

- » Wire Shelving & Components 14-17
- » Bin Storage Units 26-27
- » Stock Racks 30
- » Reel Racks 31



Myers Select

MATERIAL HANDLING

800-788-7869
www.selectlift.com

1260 N. Sunshine Way, Anaheim, CA 92806

Series 200B Bulk Storage Boltless Shelving

- » Industrial Grade Shelving
- » Heavy Duty Construction
- » No Nuts, Bolts or Shelf Clips
- » Accessible from all four sides
- » Shelves adjust on 1 ½" Centers

Series 200B - Bulk Storage Shelving offers a low cost way to store heavy and/or bulky items. Boltless design provides for easy assembly without nuts, bolts or shelf clips. No cross braces are necessary which makes these units accessible from all four sides. Available in a variety of sizes and capacities to meet your specific requirements. Shelves are easily adjustable every 1 ½". All units come complete with particle board decking. Steel color: Powder coated gray.



Heavy-duty double rivets & advanced boltless design

Shelving Label Holders

- » Durable and clear plastic will not crack, peel, fade or fall off
- » Insert paper may be reversed, re-marked and re-inserted when changes are required
- » Inkjet/Laser paper inserts included



| H x W | Qty. | Model Number | Price Each |
|-----------------|------|--------------|------------|
| Adhesive | | | |
| ¾" x 6" | 12 | 200-L231 | 24.57 |
| 1" x 6" | 12 | 200-L211 | 29.18 |
| 2" x 6" | 12 | 200-L251 | 37.32 |
| Magnetic | | | |
| 1" x 6" | 12 | 200-M211 | 30.23 |
| 2½" x 6" | 12 | 200-M261 | 60.03 |

Units are priced as either 6', 7', or 8' units. Unit prices are based on 3 shelves complete with particle board decking. Extra shelves priced to right of table. Individual units can be connected using interlocking Tie Plates. Tie Plates sold separately (see page 5)



Units can be connected using interlocking Tie Plates. See page 5 for pricing.

| Size W x D | Shelf Cap. | 6' High | | 7' High | | 8' High | | Model Number | Price Each |
|---------------------|------------|---------------|------------|---------------|------------|---------------|------------|--------------------|------------|
| | | Model Number | Price Each | Model Number | Price Each | Model Number | Price Each | | |
| 3 Shelf Unit | | | | | | | | Extra Shelf | |
| 48" x 12" | 1,000 | B3-4812-72W | 98.78 | B3-4812-84W | 104.58 | B3-4812-96W | 110.42 | BX1-4812-W | 21.30 |
| 48" x 18" | 1,000 | B3-4818-72W | 110.15 | B3-4818-84W | 115.93 | B3-4818-96W | 121.79 | BX1-4818-W | 25.09 |
| 48" x 24" | 1,000 | B3-4824-72W | 121.46 | B3-4824-84W | 127.31 | B3-4824-96W | 143.08 | BX1-4824-W | 28.88 |
| 48" x 30" | 1,000 | B3-4830-72W | 133.52 | B3-4830-84W | 139.29 | B3-4830-96W | 145.16 | BX1-4830-W | 32.87 |
| 48" x 36" | 1,000 | B3-4836-72WH | 162.02 | B3-4836-84WH | 167.74 | B3-4836-96WH | 173.66 | BX1-4836-WH | 42.36 |
| 48" x 48" | 1,000 | B3-4848-72WH | 190.25 | B3-4848-84WH | 196.01 | B3-4848-96WH | 201.89 | BX1-4848-WH | 51.78 |
| 60" x 18" | 750 | B3-6018-72W | 129.29 | B3-6018-84W | 135.26 | B3-6018-96W | 140.93 | BX1-6018-W | 31.52 |
| 60" x 18" | 1,200 | B3-6018-72WH | 140.30 | B3-6018-84WH | 146.26 | B3-6018-96WH | 151.94 | BX1-6018-WH | 35.19 |
| 60" x 24" | 750 | B3-6024-72W | 142.58 | B3-6024-84W | 148.51 | B3-6024-96W | 154.22 | BX1-6024-W | 35.94 |
| 60" x 24" | 1,200 | B3-6024-72WH | 155.81 | B3-6024-84WH | 161.72 | B3-6024-96WH | 167.45 | BX1-6024-WH | 40.34 |
| 60" x 30" | 750 | B3-6030-72W | 156.50 | B3-6030-84W | 162.07 | B3-6030-96W | 168.14 | BX1-6030-W | 40.56 |
| 60" x 30" | 1,200 | B3-6030-72WH | 171.14 | B3-6030-84WH | 177.00 | B3-6030-96WH | 182.78 | BX1-6030-WH | 45.44 |
| 60" x 36" | 750 | B3-6036-72W | 170.27 | B3-6036-84W | 176.13 | B3-6036-96W | 181.91 | BX1-6036-W | 45.14 |
| 60" x 36" | 1,200 | B3-6036-72WH | 186.83 | B3-6036-84WH | 192.69 | B3-6036-96WH | 198.47 | BX1-6036-WH | 50.66 |
| 60" x 48" | 750 | B3-6048-72W | 197.54 | B3-6048-84W | 203.40 | B3-6048-96W | 209.18 | BX1-6048-W | 54.24 |
| 60" x 48" | 1,200 | B3-6048-72WH | 218.84 | B3-6048-84WH | 224.69 | B3-6048-96WH | 230.48 | BX1-6048-WH | 61.33 |
| 72" x 18" | 600 | B3-7218-72W | 144.20 | B3-7218-84W | 149.99 | B3-7218-96W | 155.84 | BX1-7218-W | 36.43 |
| 72" x 18" | 1,000 | B3-7218-72WH | 155.21 | B3-7218-84WH | 161.00 | B3-7218-96WH | 166.85 | BX1-7218-WH | 40.11 |
| 72" x 18" | 1,500 | B3-7218-72WHC | 173.99 | B3-7218-84WHC | 179.73 | B3-7218-96WHC | 185.63 | BX1-7218-WHC | 46.35 |
| 72" x 18" | 2,000 | B3-7218-72WHR | 215.89 | B3-7218-84WHR | 236.53 | B3-7218-96WHR | 243.45 | BX1-7218-WHR | 62.57 |
| 72" x 24" | 600 | B3-7224-72W | 159.26 | B3-7224-84W | 165.12 | B3-7224-96W | 170.90 | BX1-7224-W | 41.48 |
| 72" x 24" | 1,000 | B3-7224-72WH | 172.49 | B3-7224-84WH | 178.34 | B3-7224-96WH | 184.13 | BX1-7224-WH | 45.88 |
| 72" x 24" | 1,500 | B3-7224-72WHC | 191.27 | B3-7224-84WHC | 197.06 | B3-7224-96WHC | 202.91 | BX1-7224-WHC | 52.12 |
| 72" x 24" | 2,000 | B3-7224-72WHR | 209.46 | B3-7224-84WHR | 258.36 | B3-7224-96WHR | 265.26 | BX1-7224-WHR | 69.85 |
| 72" x 30" | 600 | B3-7230-72W | 175.01 | B3-7230-84W | 180.85 | B3-7230-96W | 186.65 | BX1-7230-W | 46.73 |
| 72" x 30" | 1,000 | B3-7230-72WH | 189.65 | B3-7230-84WH | 195.50 | B3-7230-96WH | 201.29 | BX1-7230-WH | 51.60 |
| 72" x 30" | 1,500 | B3-7230-72WHC | 208.43 | B3-7230-84WHC | 214.21 | B3-7230-96WHC | 220.07 | BX1-7230-WHC | 57.83 |
| 72" x 30" | 2,000 | B3-7230-72WHR | 231.12 | B3-7230-84WHR | 280.01 | B3-7230-96WHR | 286.92 | BX1-7230-WHR | 77.06 |
| 72" x 36" | 600 | B3-7236-72W | 213.16 | B3-7236-84W | 196.49 | B3-7236-96W | 202.34 | BX1-7236-W | 51.94 |
| 72" x 36" | 1,000 | B3-7236-72WH | 207.26 | B3-7236-84WH | 213.05 | B3-7236-96WH | 218.90 | BX1-7236-WH | 57.45 |
| 72" x 36" | 1,500 | B3-7236-72WHC | 226.04 | B3-7236-84WHC | 231.76 | B3-7236-96WHC | 237.68 | BX1-7236-WHC | 63.69 |
| 72" x 36" | 2,000 | B3-7236-72WHR | 253.23 | B3-7236-84WHR | 299.56 | B3-7236-96WHR | 309.03 | BX1-7236-WHR | 84.40 |
| 72" x 48" | 600 | B3-7248-72W | 221.69 | B3-7248-84W | 227.50 | B3-7248-96W | 233.33 | BX1-7248-W | 62.27 |
| 72" x 48" | 1,000 | B3-7248-72WH | 242.99 | B3-7248-84WH | 248.81 | B3-7248-96WH | 254.63 | BX1-7248-WH | 69.37 |
| 72" x 48" | 1,500 | B3-7248-72WHC | 261.77 | B3-7248-84WHC | 267.52 | B3-7248-96WHC | 273.41 | BX1-7248-WHC | 75.61 |
| 72" x 48" | 2,000 | B3-7248-72WHR | 297.93 | B3-7248-84WHR | 346.79 | B3-7248-96WHR | 353.73 | BX1-7248-WHR | 99.32 |
| 96" x 18" | 600 | B3-9618-72WH | 185.57 | B3-9618-84WH | 191.33 | B3-9618-96WH | 197.21 | BX1-9618-WH | 50.23 |
| 96" x 18" | 1,000 | B3-9618-72WHC | 211.37 | B3-9618-84WHC | 217.17 | B3-9618-96WHC | 223.01 | BX1-9618-WHC | 58.83 |
| 96" x 18" | 1,500 | B3-9618-72WHR | 242.70 | B3-9618-84WHR | 291.49 | B3-9618-96WHR | 298.50 | BX1-9618-WHR | 80.89 |
| 96" x 24" | 600 | B3-9624-72WH | 206.60 | B3-9624-84WH | 212.41 | B3-9624-96WH | 218.24 | BX1-9624-WH | 57.35 |
| 96" x 24" | 1,000 | B3-9624-72WHC | 280.64 | B3-9624-84WHC | 238.24 | B3-9624-96WHC | 244.04 | BX1-9624-WHC | 65.85 |
| 96" x 24" | 1,500 | B3-9624-72WHR | 269.73 | B3-9624-84WHR | 318.56 | B3-9624-96WHR | 325.53 | BX1-9624-WHR | 89.91 |
| 96" x 30" | 600 | B3-9630-72WH | 227.54 | B3-9630-84WH | 233.30 | B3-9630-96WH | 239.18 | BX1-9630-WH | 64.20 |
| 96" x 30" | 1,000 | B3-9630-72WHC | 253.34 | B3-9630-84WHC | 259.14 | B3-9630-96WHC | 264.98 | BX1-9630-WHC | 72.81 |
| 96" x 30" | 1,500 | B3-9630-72WHR | 296.67 | B3-9630-84WHR | 345.45 | B3-9630-96WHR | 352.47 | BX1-9630-WHR | 98.88 |
| 96" x 36" | 600 | B3-9636-72WH | 248.87 | B3-9636-84WH | 254.61 | B3-9636-96WH | 260.51 | BX1-9636-WH | 71.30 |
| 96" x 36" | 1,000 | B3-9636-72WHC | 274.67 | B3-9636-84WHC | 280.44 | B3-9636-96WHC | 286.31 | BX1-9636-WHC | 79.92 |
| 96" x 36" | 1,500 | B3-9636-72WHR | 323.97 | B3-9636-84WHR | 372.73 | B3-9636-96WHR | 379.77 | BX1-9636-WHR | 107.97 |
| 96" x 48" | 600 | B3-9648-72WH | 292.07 | B3-9648-84WH | 297.85 | B3-9648-96WH | 303.71 | BX1-9648-WH | 85.73 |
| 96" x 48" | 1,000 | B3-9648-72WHC | 317.87 | B3-9648-84WHC | 323.69 | B3-9648-96WHC | 329.51 | BX1-9648-WHC | 94.33 |
| 96" x 48" | 1,500 | B3-9648-72WHR | 379.17 | B3-9648-84WHR | 427.96 | B3-9648-96WHR | 434.97 | BX1-9648-WHR | 126.38 |

Series 200A Low Profile Boltless Shelving

- » Industrial Grade Shelving
- » Accessible from all four sides
- » No Nuts, Bolts or Shelf Clips
- » Shelves adjust on 1½" Centers

Series 200A - This heavy duty shelving is constructed using industrial strength steel and features an advanced boltless design which provides easy assembly without nuts, bolts or shelf clips. Double Rivet Beams at top and bottom of unit form a rigid structure without the use of troublesome crossbars. Steel color: Powder coated gray.

Units come standard as either 6', 7' or 8' units with 5 shelves. Regular Load Capacity units are priced complete with ½" particle board decking. Heavy Load Capacity units are priced complete with ¾" particle board decking. See below for pricing of extra shelves.



Units can be connected using interlocking Tie Plates. See page 5 for pricing.



Label Holders See page 2 for details

| Size W x D | Shelf Cap. | 6' High | | 7' High | | 8' High | | Model Number | Price Each |
|---|------------|--------------|------------|--------------|------------|--------------|------------|--------------------|------------|
| | | Model Number | Price Each | Model Number | Price Each | Model Number | Price Each | | |
| Regular Load Capacity - 5 Shelf Unit | | | | | | | | Extra Shelf | |
| 36" x 12" | 300 | A5-3612-72W | 99.45 | A5-3612-84W | 105.18 | A5-3612-96W | 111.09 | AX1-3612-W | 10.03 |
| 36" x 18" | 300 | A5-3618-72W | 111.40 | A5-3618-84W | 117.13 | A5-3618-96W | 123.04 | AX1-3618-W | 11.91 |
| 36" x 24" | 300 | A5-3624-72W | 123.31 | A5-3624-84W | 129.08 | A5-3624-96W | 134.95 | AX1-3624-W | 13.77 |
| 36" x 30" | 250 | A5-3630-72W | 135.80 | A5-3630-84W | 141.60 | A5-3630-96W | 147.44 | AX1-3630-W | 15.68 |
| 42" x 12" | 225 | A5-4212-72W | 86.90 | A5-4212-84W | 92.70 | A5-4212-96W | 98.54 | AX1-4212-W | 7.42 |
| 42" x 18" | 225 | A5-4218-72W | 123.65 | A5-4218-84W | 129.45 | A5-4218-96W | 135.29 | AX1-4218-W | 14.25 |
| 42" x 24" | 225 | A5-4224-72W | 133.06 | A5-4224-84W | 138.86 | A5-4224-96W | 144.70 | AX1-4224-W | 15.62 |
| 42" x 30" | 225 | A5-4230-72W | 149.65 | A5-4230-84W | 155.45 | A5-4230-96W | 161.29 | AX1-4230-W | 18.33 |
| 42" x 36" | 225 | A5-4236-72W | 163.71 | A5-4236-84W | 169.51 | A5-4236-96W | 175.35 | AX1-4236-W | 20.55 |
| 48" x 12" | 225 | A5-4812-72W | 116.06 | A5-4812-84W | 121.82 | A5-4812-96W | 127.70 | AX1-4812-W | 12.85 |
| 48" x 18" | 225 | A5-4818-72W | 131.11 | A5-4818-84W | 136.90 | A5-4818-96W | 142.75 | AX1-4818-W | 15.34 |
| 48" x 24" | 225 | A5-4824-72W | 146.12 | A5-4824-84W | 151.97 | A5-4824-96W | 157.76 | AX1-4824-W | 17.85 |
| 48" x 30" | 225 | A5-4830-72W | 161.66 | A5-4830-84W | 167.46 | A5-4830-96W | 173.30 | AX1-4830-W | 20.34 |
| 48" x 36" | 225 | A5-4836-72W | 177.12 | A5-4836-84W | 201.75 | A5-4836-96W | 188.76 | AX1-4836-W | 29.13 |
| 60" x 12" | 150 | A5-6012-72W | 160.68 | A5-6012-84W | 166.55 | A5-6012-96W | 172.32 | AX1-6012-W | 23.88 |
| 60" x 18" | 150 | A5-6018-72W | 178.73 | A5-6018-84W | 184.75 | A5-6018-96W | 190.37 | AX1-6018-W | 27.00 |
| 60" x 24" | 150 | A5-6024-72W | 197.04 | A5-6024-84W | 202.94 | A5-6024-96W | 208.68 | AX1-6024-W | 30.12 |
| 60" x 30" | 150 | A5-6030-72W | 215.68 | A5-6030-84W | 221.48 | A5-6030-96W | 227.32 | AX1-6030-W | 33.24 |
| 60" x 36" | 150 | A5-6036-72W | 234.19 | A5-6036-84W | 258.95 | A5-6036-96W | 245.83 | AX1-6036-W | 36.37 |
| Heavy Load Capacity - 5 Shelf Unit | | | | | | | | Extra Shelf | |
| 36" x 12" | 500 | AH5-3612-72W | 128.69 | AH5-3612-84W | 134.53 | AH5-3612-96W | 140.33 | AXH1-3612-W | 18.82 |
| 36" x 18" | 500 | AH5-3618-72W | 147.80 | AH5-3618-84W | 153.60 | AH5-3618-96W | 159.44 | AXH1-3618-W | 22.57 |
| 36" x 24" | 500 | AH5-3624-72W | 165.91 | AH5-3624-84W | 171.76 | AH5-3624-96W | 177.55 | AXH1-3624-W | 26.01 |
| 36" x 30" | 500 | AH5-3630-72W | 186.01 | AH5-3630-84W | 191.81 | AH5-3630-96W | 197.65 | AXH1-3630-W | 29.93 |
| 48" x 12" | 375 | AH5-4812-72W | 153.67 | AH5-4812-84W | 159.43 | AH5-4812-96W | 165.31 | AXH1-4812-W | 24.06 |
| 48" x 18" | 375 | AH5-4818-72W | 177.13 | AH5-4818-84W | 182.87 | AH5-4818-96W | 188.77 | AXH1-4818-W | 28.68 |
| 48" x 24" | 375 | AH5-4824-72W | 199.49 | AH5-4824-84W | 205.41 | AH5-4824-96W | 211.13 | AXH1-4824-W | 33.00 |
| 48" x 30" | 375 | AH5-4830-72W | 223.99 | AH5-4830-84W | 229.79 | AH5-4830-96W | 235.63 | AXH1-4830-W | 37.79 |
| 48" x 36" | 375 | AH5-4836-72W | 246.19 | AH5-4836-84W | 251.91 | AH5-4836-96W | 257.83 | AXH1-4836-W | 41.86 |
| 60" x 12" | 250 | AH5-6012-72W | 180.57 | AH5-6012-84W | 186.45 | AH5-6012-96W | 192.21 | AXH1-6012-W | 28.86 |
| 60" x 18" | 250 | AH5-6018-72W | 208.43 | AH5-6018-84W | 214.25 | AH5-6018-96W | 220.07 | AXH1-6018-W | 34.35 |
| 60" x 24" | 250 | AH5-6024-72W | 235.19 | AH5-6024-84W | 241.16 | AH5-6024-96W | 246.83 | AXH1-6024-W | 39.54 |
| 60" x 30" | 250 | AH5-6030-72W | 264.09 | AH5-6030-84W | 269.89 | AH5-6030-96W | 275.73 | AXH1-6030-W | 45.21 |
| 60" x 36" | 250 | AH5-6036-72W | 290.54 | AH5-6036-84W | 296.39 | AH5-6036-96W | 302.18 | AXH1-6036-W | 50.14 |



Upright Posts
» 14 gauge steel construction

| Height | Model Number | Price Each |
|---|--------------|------------|
| Regular Duty - 1 1/2"W x 1 1/2"D | | |
| 2.5' | 200-P2.5 | 3.63 |
| 3' | 200-P3 | 4.35 |
| 4' | 200-P4 | 5.82 |
| 5' | 200-P5 | 7.28 |
| 6' | 200-P6 | 8.72 |
| 7' | 200-P7 | 10.17 |
| 8' | 200-P8 | 11.63 |
| 9' | 200-P9 | 13.09 |
| 10' | 200-P10 | 14.54 |
| 12' | 200-P12 | 17.45 |
| Heavy Duty - 1 7/8"W x 1 7/8"D | | |
| 7' | 200-PH7 | 12.20 |
| 8' | 200-PH8 | 13.95 |
| 10' | 200-PH10 | 17.45 |
| 12' | 200-PH12 | 20.96 |
| 15' | 200-PH15 | 26.60 |



| Description | Model Number | Price Each |
|-----------------------|--------------|------------|
| (A) Tie Plate | 200-TP | 0.91 |
| (B) Wall Tie | 200-WT09 | 3.42 |
| (C) Left Foot Plate | 200-FPL | 1.78 |
| (D) Double Foot Plate | 200-FPD | 2.33 |
| (E) Right Foot Plate | 200-FPR | 1.78 |



Single Rivet Beams
» 1" Height
» Use as a left to right or front to back

| Height | Model Number | Price Each |
|--------------------------------------|--------------|------------|
| Regular Duty - 14 gauge steel | | |
| 12" | 200-SR12 | 1.24 |
| 18" | 200-SR18 | 1.80 |
| 24" | 200-SR24 | 2.20 |
| 30" | 200-SR30 | 2.86 |
| 36" | 200-SR36 | 3.15 |
| 42" | 200-SR42 | 3.71 |
| 48" | 200-SR48 | 3.93 |
| Heavy Duty - 11 gauge steel | | |
| 36" | 200-SRH36 | 5.55 |
| 48" | 200-SRH48 | 7.30 |
| 60" | 200-SRH60 | 8.82 |



Shelf Deck Supports
» 16 gauge steel
» 2 1/2" Height
» Adds capacity to shelf when bolted between double rivet beams

| Length | Model Number | Price Each |
|--------|--------------|------------|
| 12" | 200-SDS12 | 3.40 |
| 15" | 200-SDS15 | 3.54 |
| 18" | 200-SDS18 | 3.67 |
| 24" | 200-SDS24 | 4.41 |
| 30" | 200-SDS30 | 4.88 |
| 36" | 200-SDS36 | 5.52 |
| 48" | 200-SDS48 | 7.10 |



Double Rivet Beams
» 16 gauge steel (12"-48" beams)
» 14 gauge steel (60"-96" beams)
» 2 3/4" Height
» Use as a left to right or front to back

| Length | Model Number | Price Each |
|--------|--------------|------------|
| 12" | 200-DR12 | 1.97 |
| 15" | 200-DR15 | 2.25 |
| 18" | 200-DR18 | 2.62 |
| 24" | 200-DR24 | 3.26 |
| 30" | 200-DR30 | 4.02 |
| 36" | 200-DR36 | 4.76 |
| 42" | 200-DR42 | 5.47 |
| 48" | 200-DR48 | 6.18 |
| 60" | 200-DR60 | 8.45 |
| 69" | 200-DR69 | 9.98 |
| 72" | 200-DR72 | 9.98 |
| 84" | 200-DR84 | 11.66 |
| 96" | 200-DR96 | 13.17 |

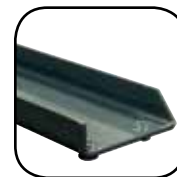

Double Rivet Channel Beams
» 2 3/4" Height
» Use as a left to right or front to back

| Length | Model Number | Price Each |
|--------------------------------------|--------------|------------|
| Regular Duty - 14 gauge steel | | |
| 72" | 200-DC72 | 13.11 |
| 96" | 200-DC96 | 17.47 |
| Heavy Duty - 11 gauge steel | | |
| 72" | 200-DCH72 | 18.96 |
| 96" | 200-DCH96 | 25.51 |



Particle Board Decking for Boltless Shelving

Provides a strong and durable shelf surface. 1/2" particle board decking is recommended for standard to light-duty applications. 3/4" decking is ideal for heavy-duty applications. Decking provides smooth worksurface and enhances the appearance of shelving

| 1/2" Particle Board | | | 3/4" Particle Board | |
|---------------------|--------------|------------|---------------------|------------|
| Size W x D | Model Number | Price Each | Model Number | Price Each |
| 36" x 12" | 240-013612 | 3.75 | 240-023612 | 5.23 |
| 36" x 18" | 240-013618 | 5.62 | 240-023618 | 7.86 |
| 36" x 24" | 240-013624 | 7.49 | 240-023624 | 10.49 |
| 36" x 36" | 240-013636 | 11.24 | 240-023636 | 15.72 |
| 42" x 15" | 240-014215 | 5.47 | 240-024215 | 7.65 |
| 42" x 18" | 240-014218 | 6.56 | 240-024218 | 9.19 |
| 42" x 24" | 240-014224 | 8.75 | 240-024224 | 12.25 |
| 42" x 30" | 240-014230 | 10.94 | 240-024230 | 15.31 |
| 48" x 12" | 240-014812 | 5.00 | 240-024812 | 6.99 |
| 48" x 18" | 240-014818 | 7.49 | 240-024818 | 10.49 |
| 48" x 24" | 240-014824 | 9.98 | 240-024824 | 13.97 |
| 48" x 30" | 240-014830 | 12.48 | 240-024830 | 17.47 |
| 48" x 36" | 240-014836 | 14.98 | 240-024836 | 20.97 |
| 48" x 42" | 240-014842 | 17.50 | 240-024842 | 24.50 |
| 48" x 48" | 240-014848 | 19.97 | 240-024848 | 27.96 |
| 60" x 12" | 240-016012 | 6.24 | 240-026012 | 8.73 |
| 60" x 18" | 240-016018 | 9.33 | 240-026018 | 13.11 |
| 60" x 24" | 240-016024 | 12.48 | 240-026024 | 17.47 |
| 60" x 30" | 240-016030 | 15.60 | 240-026030 | 21.85 |
| 60" x 36" | 240-016036 | 18.71 | 240-026036 | 26.20 |
| 60" x 42" | 240-016042 | 21.88 | 240-026042 | 30.63 |
| 60" x 48" | 240-016048 | 24.96 | 240-026048 | 34.95 |

| 1/2" Particle Board | | | 3/4" Particle Board | |
|---------------------|--------------|------------|---------------------|------------|
| Size W x D | Model Number | Price Each | Model Number | Price Each |
| 69" x 15" | 240-016915 | 8.97 | 240-026915 | 12.55 |
| 69" x 30" | 240-016930 | 17.95 | 240-026930 | 25.12 |
| 72" x 12" | 240-017212 | 5.62 | 240-027212 | 10.49 |
| 72" x 18" | 240-017218 | 11.24 | 240-027218 | 15.72 |
| 72" x 24" | 240-017224 | 14.98 | 240-027224 | 20.97 |
| 72" x 30" | 240-017230 | 18.71 | 240-027230 | 26.20 |
| 72" x 36" | 240-017236 | 22.46 | 240-027236 | 31.45 |
| 72" x 42" | 240-017242 | 26.25 | 240-027242 | 36.75 |
| 72" x 48" | 240-017248 | 29.95 | 240-027248 | 41.93 |
| 84" x 12" | 240-018412 | 8.73 | 240-028412 | 12.23 |
| 84" x 18" | 240-018418 | 13.11 | 240-028418 | 18.35 |
| 84" x 24" | 240-018424 | 17.47 | 240-028424 | 24.46 |
| 84" x 30" | 240-018430 | 21.85 | 240-028430 | 30.58 |
| 84" x 36" | 240-018436 | 26.20 | 240-028436 | 36.69 |
| 84" x 42" | 240-018442 | 30.63 | 240-028442 | 42.88 |
| 84" x 48" | 240-018448 | 34.95 | 240-028448 | 48.91 |
| 96" x 12" | 240-019612 | 9.98 | 240-029612 | 13.97 |
| 96" x 18" | 240-019618 | 14.98 | 240-029618 | 20.97 |
| 96" x 24" | 240-019624 | 19.97 | 240-029624 | 27.96 |
| 96" x 30" | 240-019630 | 24.96 | 240-029630 | 34.95 |
| 96" x 36" | 240-019636 | 29.95 | 240-029636 | 41.93 |
| 96" x 42" | 240-019642 | 35.00 | 240-029642 | 49.00 |
| 96" x 48" | 240-019648 | 39.93 | 240-029648 | 55.91 |

FastRak Bulk Storage Shelving

Save time and money with this heavy-duty bulk storage shelving. Featuring a newly designed heavier duty upright that can be "knocked down" for easier shipment as well as having the advantage of component replacement in case of damage. Uprights can be shipped pre-assembled for an additional charge. Ideal for storing bulky and/or heavy items. Choose between wire mesh or particle board decking for shelf surface.

You can design your own system by purchasing the components individually (pages 6-7) or order complete units (pages 8-11) with your choice of wire mesh or particle board decking. When ordering components, you must use steel supports in conjunction with particle board decking.



FastRak is unique because it does not require a shelf at the bottom of the unit.

- **Tear Drop Design**
Allows for quick/easy set-up
- **Built-in Safety Clip**
Secures the beam to upright for added safety
- **Knockdown Upright**
Newly designed heavier duty upright that can be knocked down for easier shipment



- » Uprights allow adjustment of shelf height every 1½"
- » 7,000 lbs. capacity per upright (based upon 36" max. shelf spacing)
- » Knock down heavy duty upright design

FastRak Uprights

Featuring a newly designed heavier duty upright that can be "knocked down" with detachable supports. Design allows for easier shipment while still providing up to 7,000 lbs. capacity per upright. Units feature a teardrop design that provides quick/easy assembly, as well as the functionality of sharing a common upright between units. Beams are adjustable in 1½". Uprights are shipped Knocked Down or assembled for an additional charge. Upright color: Green.

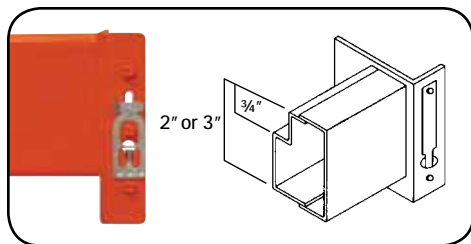

Step Load Beams

High capacity beams provide exceptional strength at a reasonable price. Built-in safety lock at end of beams helps prevent beams from accidentally getting knocked off uprights. Beam length is measured by clear span between uprights. Beams are designed specifically for use with wire mesh or ¾" particle board decking. Beam color: Orange.

| D x H | Unassembled | | Assembled | |
|------------|--------------|------------|--------------|------------|
| | Model Number | Price Each | Model Number | Price Each |
| 18" x 72" | CU18072 | 42.67 | CU18072A | 46.94 |
| 18" x 96" | CU18096 | 52.24 | CU18096A | 57.46 |
| 18" x 120" | CU18120 | 65.22 | CU18120A | 71.74 |
| 24" x 72" | CU24072 | 45.44 | CU24072A | 49.98 |
| 24" x 96" | CU24096 | 54.97 | CU24096A | 60.47 |
| 24" x 120" | CU24120 | 67.89 | CU24120A | 74.68 |
| 36" x 72" | CU36072 | 54.12 | CU36072A | 59.53 |
| 36" x 96" | CU36096 | 63.65 | CU36096A | 70.02 |
| 36" x 120" | CU36120 | 73.18 | CU36120A | 80.50 |
| 36" x 144" | CU36144 | 82.71 | CU36144A | 90.98 |
| 48" x 72" | CU48072 | 62.80 | CU48072A | 69.08 |
| 48" x 96" | CU48096 | 72.34 | CU48096A | 79.57 |
| 48" x 120" | CU48120 | 81.87 | CU48120A | 90.06 |
| 48" x 144" | CU48144 | 91.41 | CU48144A | 100.55 |

- » Available in either 2" or 3" beam heights
- » Available in 24", 36", 48", 72" or 96" in length
- » Built-in safety clip for added safety

| H x L | Cap. Per Pair | Model Number | Price Each |
|----------|---------------|--------------|------------|
| 2" x 48" | 1,400 | 215-CB20048 | 14.16 |
| 2" x 72" | 1,200 | 215-CB20072 | 20.36 |
| 2" x 96" | 1,000 | 215-CB20096 | 26.57 |
| 3" x 24" | 1,400 | 215-CBL30024 | 8.16 |
| 3" x 36" | 1,200 | 215-CBL30036 | 11.80 |
| 3" x 48" | 2,000 | 215-CB30048 | 17.44 |
| 3" x 72" | 1,800 | 215-CB30072 | 25.28 |
| 3" x 96" | 1,600 | 215-CB30096 | 33.14 |



Multiple units can share common column, saving money and providing a more rigid rack system.



Wire deck rests securely on top of beam. Integrated steel deck supports provide for high capacity.



Shelf Supports

Used in conjunction with particle board to maximize shelf capacity. Shelf supports fit into notches in beams to maintain a level shelf surface. Support color: Orange

| Length | Model Number | Price Each |
|--------|--------------|------------|
| 24" | 215-CSS24 | 3.08 |
| 36" | 215-CSS36 | 4.61 |
| 48" | 215-CSS48 | 6.08 |

Particle Board Decking

Heavy duty 3/4" particle board rests on the ledge of step beams and is flush with top of beam to provide smooth shelf surface.

| D x L | Model Number | Price Each |
|-----------|--------------|------------|
| 18" x 48" | 240-044818 | 10.49 |
| 18" x 72" | 240-047218 | 15.72 |
| 18" x 96" | 240-049618 | 20.97 |
| 24" x 48" | 240-044824 | 13.97 |
| 24" x 72" | 240-047224 | 20.97 |
| 24" x 96" | 240-049624 | 27.96 |
| 36" x 48" | 240-044836 | 20.97 |
| 36" x 72" | 240-047236 | 31.45 |
| 36" x 96" | 240-049636 | 41.93 |
| 48" x 48" | 240-044848 | 27.96 |
| 48" x 72" | 240-047248 | 41.93 |
| 48" x 96" | 240-049648 | 55.91 |



Deluxe Foot Plates

Foot plates are an optional addition to FastRak uprights. Foot plates easily bolt into the upright and allow FastRak to be anchored into concrete for additional safety or permanent placement. Color: Green. Concrete wedge anchors are sold separately (not shown).

| Deluxe Foot Plate | | Concrete Wedge Anchor | |
|-------------------|------------|-----------------------|------------|
| Model Number | Price Each | Model Number | Price Each |
| CUCF01 | 3.08 | 235-FA01 | 1.07 |



Wire Mesh Decking

Improves ventilation and reduces dust build-up. Designed specifically for the FastRak product, this wire mesh decking fits perfectly on top of beams. Waterfall design of wire mesh curves over top of beams to provide smooth shelf surface. Combine multiple decks for longer shelf widths. Color: Gray.

| Deck D x W | Model Number | Price Each |
|------------|--------------|------------|
| 18" x 35" | 215-CW1835 | 23.96 |
| 18" x 47" | 215-CW1847 | 25.78 |
| 24" x 35" | 215-CW2435 | 26.02 |
| 24" x 47" | 215-CW2447 | 28.17 |
| 36" x 35" | 215-CW3635 | 30.20 |
| 36" x 47" | 215-CW3647 | 32.97 |
| 48" x 35" | 215-CW4835 | 33.84 |
| 48" x 47" | 215-CW4847 | 37.99 |



Label Holders

These durable label holders are extra large and ideal for FastRak or Pallet Rack applications. Self-Adhesive or Magnetic label holders are available and allows for simple label relocation. Side loading. Includes Inkjet/Laser compatible white inserts with instructions. Bar code compatible.

| | | Adhesive | | Magnetic | |
|---------|------|--------------|------------|--------------|------------|
| H x W | Qty. | Model Number | Price Each | Model Number | Price Each |
| 3" x 5" | 50 | 215-L335 | 61.82 | 215-L335M | 85.60 |

FastRak Units with Particle Board Decking

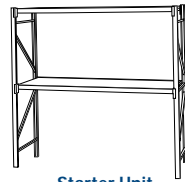

Starter Unit

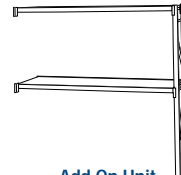

Add-On Unit



| Size W x D | Beam H | Shelf Cap. | Model Number | Price Each | Model Number | Price Each | Model Number | Price Each |
|----------------------|--------|------------|--------------|------------|--------------|--------------------|--------------|------------|
| 6' HIGH UNITS | | | | | | Extra Shelf | | |
| 18" x 48" | 2" | 1,400 | KS2-4818072W | 162.96 | KT2-4818072W | 120.29 | KX2-4818W | 38.81 |
| 18" x 48" | 3" | 2,000 | KS3-4818072W | 176.08 | KT3-4818072W | 133.41 | KX3-4818W | 45.37 |
| 18" x 72" | 2" | 1,200 | KS2-7218072W | 198.22 | KT2-7218072W | 155.55 | KX2-7218W | 56.44 |
| 18" x 72" | 3" | 1,800 | KS3-7218072W | 217.90 | KT3-7218072W | 175.23 | KX3-7218W | 66.28 |
| 18" x 96" | 2" | 1,000 | KS2-9618072W | 233.56 | KT2-9618072W | 190.89 | KX2-9618W | 74.11 |
| 18" x 96" | 3" | 1,600 | KS3-9618072W | 259.84 | KT3-9618072W | 217.17 | KX3-9618W | 87.25 |
| 24" x 48" | 2" | 1,400 | KS2-4824072W | 181.62 | KT2-4824072W | 142.34 | KX2-4824W | 48.45 |
| 24" x 48" | 3" | 2,000 | KS3-4824072W | 200.90 | KT3-4824072W | 155.46 | KX3-4824W | 55.01 |
| 24" x 72" | 2" | 1,200 | KS2-7224072W | 232.74 | KT2-7224072W | 187.30 | KX2-7224W | 70.93 |
| 24" x 72" | 3" | 1,800 | KS3-7224072W | 252.42 | KT3-7224072W | 206.98 | KX3-7224W | 80.77 |
| 24" x 96" | 2" | 1,000 | KS2-9624072W | 277.72 | KT2-9624072W | 232.28 | KX2-9624W | 93.42 |
| 24" x 96" | 3" | 1,600 | KS3-9624072W | 304.00 | KT3-9624072W | 258.56 | KX3-9624W | 106.56 |
| 36" x 48" | 2" | 1,400 | KS2-4836072W | 225.26 | KT2-4836072W | 171.14 | KX2-4836W | 58.51 |
| 36" x 48" | 3" | 2,000 | KS3-4836072W | 238.38 | KT3-4836072W | 184.26 | KX3-4836W | 65.07 |
| 36" x 72" | 2" | 1,200 | KS2-7236072W | 280.24 | KT2-7236072W | 226.12 | KX2-7236W | 86.00 |
| 36" x 72" | 3" | 1,800 | KS3-7236072W | 299.92 | KT3-7236072W | 245.80 | KX3-7236W | 95.84 |
| 36" x 96" | 2" | 1,000 | KS2-9636072W | 335.26 | KT2-9636072W | 281.14 | KX2-9636W | 113.51 |
| 36" x 96" | 3" | 1,600 | KS3-9636072W | 361.54 | KT3-9636072W | 307.42 | KX3-9636W | 126.65 |
| 48" x 48" | 2" | 1,400 | KS2-4848072W | 262.48 | KT2-4848072W | 199.68 | KX2-4848W | 68.44 |
| 48" x 48" | 3" | 2,000 | KS3-4848072W | 275.60 | KT3-4848072W | 212.80 | KX3-4848W | 75.00 |
| 48" x 72" | 2" | 1,200 | KS2-7248072W | 327.38 | KT2-7248072W | 264.58 | KX2-7248W | 100.89 |
| 48" x 72" | 3" | 1,800 | KS3-7248072W | 347.06 | KT3-7248072W | 284.26 | KX3-7248W | 110.73 |
| 48" x 96" | 2" | 1,000 | KS2-9648072W | 392.34 | KT2-9648072W | 329.54 | KX2-9648W | 133.37 |
| 48" x 96" | 3" | 1,600 | KS3-9648072W | 418.62 | KT3-9648072W | 355.82 | KX3-9648W | 146.51 |
| 8' HIGH UNITS | | | | | | Extra Shelf | | |
| 18" x 48" | 2" | 1,400 | KS2-4818096W | 182.10 | KT2-4818096W | 129.86 | KX2-4818W | 38.81 |
| 18" x 48" | 3" | 2,000 | KS3-4818096W | 195.22 | KT3-4818096W | 142.98 | KX3-4818W | 45.37 |
| 18" x 72" | 2" | 1,200 | KS2-7218096W | 217.36 | KT2-7218096W | 165.12 | KX2-7218W | 56.44 |
| 18" x 72" | 3" | 1,800 | KS3-7218096W | 237.04 | KT3-7218096W | 184.80 | KX3-7218W | 66.28 |
| 18" x 96" | 2" | 1,000 | KS2-9618096W | 252.70 | KT2-9618096W | 200.46 | KX2-9618W | 74.11 |
| 18" x 96" | 3" | 1,600 | KS3-9618096W | 278.98 | KT3-9618096W | 226.74 | KX3-9618W | 87.25 |
| 24" x 48" | 2" | 1,400 | KS2-4824096W | 206.84 | KT2-4824096W | 151.87 | KX2-4824W | 48.45 |
| 24" x 48" | 3" | 2,000 | KS3-4824096W | 219.96 | KT3-4824096W | 164.99 | KX3-4824W | 55.01 |
| 24" x 72" | 2" | 1,200 | KS2-7224096W | 251.80 | KT2-7224096W | 196.83 | KX2-7224W | 70.93 |
| 24" x 72" | 3" | 1,800 | KS3-7224096W | 271.48 | KT3-7224096W | 216.51 | KX3-7224W | 80.77 |
| 24" x 96" | 2" | 1,000 | KS2-9624096W | 296.78 | KT2-9624096W | 241.81 | KX2-9624W | 93.42 |
| 24" x 96" | 3" | 1,600 | KS3-9624096W | 323.06 | KT3-9624096W | 268.09 | KX3-9624W | 106.56 |
| 36" x 48" | 2" | 1,400 | KS2-4836096W | 244.32 | KT2-4836096W | 180.67 | KX2-4836W | 58.51 |
| 36" x 48" | 3" | 2,000 | KS3-4836096W | 257.44 | KT3-4836096W | 193.79 | KX3-4836W | 65.07 |
| 36" x 72" | 2" | 1,200 | KS2-7236096W | 299.30 | KT2-7236096W | 235.65 | KX2-7236W | 86.00 |
| 36" x 72" | 3" | 1,800 | KS3-7236096W | 318.98 | KT3-7236096W | 255.33 | KX3-7236W | 95.84 |
| 36" x 96" | 2" | 1,000 | KS2-9636096W | 354.32 | KT2-9636096W | 290.67 | KX2-9636W | 113.51 |
| 36" x 96" | 3" | 1,600 | KS3-9636096W | 380.60 | KT3-9636096W | 316.95 | KX3-9636W | 126.65 |
| 48" x 48" | 2" | 1,400 | KS2-4848096W | 281.56 | KT2-4848096W | 209.22 | KX2-4848W | 68.44 |
| 48" x 48" | 3" | 2,000 | KS3-4848096W | 294.68 | KT3-4848096W | 222.34 | KX3-4848W | 75.00 |
| 48" x 72" | 2" | 1,200 | KS2-7248096W | 346.46 | KT2-7248096W | 274.12 | KX2-7248W | 100.89 |
| 48" x 72" | 3" | 1,800 | KS3-7248096W | 366.14 | KT3-7248096W | 293.80 | KX3-7248W | 110.73 |
| 48" x 96" | 2" | 1,000 | KS2-9648096W | 411.42 | KT2-9648096W | 339.08 | KX2-9648W | 133.37 |
| 48" x 96" | 3" | 1,600 | KS3-9648096W | 437.70 | KT3-9648096W | 365.36 | KX3-9648W | 146.51 |

These complete units (pages 8-9) are priced to include industrial strength 3/4" particle board decking that provides a smooth and durable shelf surface that sits flush with the top of beams allowing for easy loading and unloading of stored material. Priced as 2 shelf units that can be set-up so that goods can be stored on floor. Choose between 6', 8', 10' or 12' tall units. Extra shelf pricing to right of the tables. Uprights can be shipped pre-assembled for an additional charge. Units with wire mesh decking are available on pages 10-11.

When placing an order, please use "W" for particle board decking at the end of the model number.



Model Number Code: KS2-4818072W

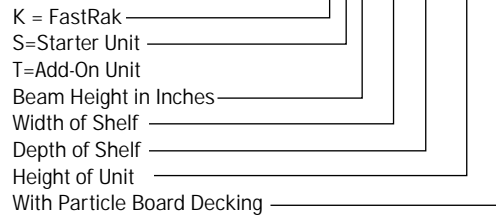

Anchor uprights to concrete floors with foot plates and anchors (See page 7)

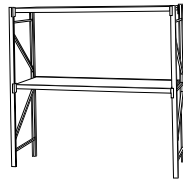

Starter Unit

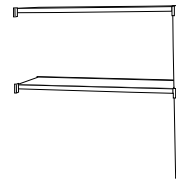

Add-On Unit



| Size W x D | Beam H | Shelf Cap. | Model Number | Price Each | Model Number | Price Each | Model Number | Price Each |
|------------|--------|------------|-----------------------|------------|--------------|--------------------|--------------|------------|
| | | | 10' HIGH UNITS | | | Extra Shelf | | |
| 18" x 48" | 2" | 1,400 | KS2-4818120W | 208.06 | KT2-4818120W | 142.84 | KX2-4818W | 38.81 |
| 18" x 48" | 3" | 2,000 | KS3-4818120W | 221.18 | KT3-4818120W | 155.96 | KX3-4818W | 45.37 |
| 18" x 72" | 2" | 1,200 | KS2-7218120W | 243.32 | KT2-7218120W | 178.10 | KX2-7218W | 56.44 |
| 18" x 72" | 3" | 1,800 | KS3-7218120W | 263.00 | KT3-7218120W | 197.78 | KX3-7218W | 66.28 |
| 18" x 96" | 2" | 1,000 | KS2-9618120W | 278.66 | KT2-9618120W | 213.44 | KX2-9618W | 74.11 |
| 18" x 96" | 3" | 1,600 | KS3-9618120W | 304.94 | KT3-9618120W | 239.72 | KX3-9618W | 87.25 |
| 24" x 48" | 2" | 1,400 | KS2-4824120W | 232.68 | KT2-4824120W | 164.79 | KX2-4824W | 48.45 |
| 24" x 48" | 3" | 2,000 | KS3-4824120W | 245.80 | KT3-4824120W | 177.91 | KX3-4824W | 55.01 |
| 24" x 72" | 2" | 1,200 | KS2-7224120W | 277.64 | KT2-7224120W | 209.75 | KX2-7224W | 70.93 |
| 24" x 72" | 3" | 1,800 | KS3-7224120W | 297.32 | KT3-7224120W | 229.43 | KX3-7224W | 80.77 |
| 24" x 96" | 2" | 1,000 | KS2-9624120W | 322.62 | KT2-9624120W | 254.73 | KX2-9624W | 93.42 |
| 24" x 96" | 3" | 1,600 | KS3-9624120W | 348.90 | KT3-9624120W | 281.01 | KX3-9624W | 106.56 |
| 36" x 48" | 2" | 1,400 | KS2-4836120W | 276.50 | KT2-4836120W | 190.20 | KX2-4836W | 58.51 |
| 36" x 48" | 3" | 2,000 | KS3-4836120W | 263.38 | KT3-4836120W | 203.32 | KX3-4836W | 65.07 |
| 36" x 72" | 2" | 1,200 | KS2-7236120W | 318.36 | KT2-7236120W | 245.18 | KX2-7236W | 86.00 |
| 36" x 72" | 3" | 1,800 | KS3-7236120W | 347.26 | KT3-7236120W | 274.08 | KX3-7236W | 95.84 |
| 36" x 96" | 2" | 1,000 | KS2-9636120W | 373.38 | KT2-9636120W | 300.20 | KX2-9636W | 113.51 |
| 36" x 96" | 3" | 1,600 | KS3-9636120W | 399.66 | KT3-9636120W | 326.48 | KX3-9636W | 126.65 |
| 48" x 48" | 2" | 1,400 | KS2-4848120W | 300.62 | KT2-4848120W | 218.75 | KX2-4848W | 68.44 |
| 48" x 48" | 3" | 2,000 | KS3-4848120W | 313.74 | KT3-4848120W | 231.87 | KX3-4848W | 75.00 |
| 48" x 72" | 2" | 1,200 | KS2-7248120W | 365.52 | KT2-7248120W | 283.65 | KX2-7248W | 100.89 |
| 48" x 72" | 3" | 1,800 | KS3-7248120W | 385.20 | KT3-7248120W | 303.33 | KX3-7248W | 110.73 |
| 48" x 96" | 2" | 1,000 | KS2-9648120W | 430.48 | KT2-9648120W | 348.61 | KX2-9648W | 133.37 |
| 48" x 96" | 3" | 1,600 | KS3-9648120W | 456.76 | KT3-9648120W | 374.89 | KX3-9648W | 146.51 |
| | | | 12' HIGH UNITS | | | Extra Shelf | | |
| 36" x 48" | 2" | 1,400 | KS2-4836144W | 282.44 | KT2-4836144W | 199.73 | KX2-4836W | 58.51 |
| 36" x 48" | 3" | 2,000 | KS3-4836144W | 295.56 | KT3-4836144W | 212.85 | KX3-4836W | 65.07 |
| 36" x 72" | 2" | 1,200 | KS2-7236144W | 337.42 | KT2-7236144W | 254.71 | KX2-7236W | 86.00 |
| 36" x 72" | 3" | 1,800 | KS3-7236144W | 357.10 | KT3-7236144W | 274.39 | KX3-7236W | 95.84 |
| 36" x 96" | 2" | 1,000 | KS2-9636144W | 392.44 | KT2-9636144W | 309.73 | KX2-9636W | 113.51 |
| 36" x 96" | 3" | 1,600 | KS3-9636144W | 418.72 | KT3-9636144W | 336.01 | KX3-9636W | 126.65 |
| 48" x 48" | 2" | 1,400 | KS2-4848144W | 319.70 | KT2-4848144W | 228.29 | KX2-4848W | 68.44 |
| 48" x 48" | 3" | 2,000 | KS3-4848144W | 332.82 | KT3-4848144W | 241.41 | KX3-4848W | 75.00 |
| 48" x 72" | 2" | 1,200 | KS2-7248144W | 384.60 | KT2-7248144W | 293.19 | KX2-7248W | 100.89 |
| 48" x 72" | 3" | 1,800 | KS3-7248144W | 404.28 | KT3-7248144W | 312.87 | KX3-7248W | 110.73 |
| 48" x 96" | 2" | 1,000 | KS2-9648144W | 449.56 | KT2-9648144W | 358.15 | KX2-9648W | 133.37 |
| 48" x 96" | 3" | 1,600 | KS3-9648144W | 475.84 | KT3-9648144W | 384.43 | KX3-9648W | 146.51 |

FastRak Units with Wire Mesh Decking

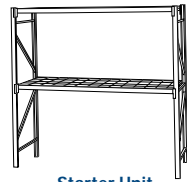

Starter Unit



Add-On Unit



| Size W x D | Beam H | Shelf Cap. | Model Number | Price Each | Model Number | Price Each | Model Number | Price Each |
|----------------------|--------|------------|--------------|------------|--------------|------------|--------------------|------------|
| 6' HIGH UNITS | | | | | | | Extra Shelf | |
| 18" x 48" | 2" | 1,400 | KS2-4818072M | 193.54 | KT2-4818072M | 150.87 | KX2-4818M | 54.10 |
| 18" x 48" | 3" | 2,000 | KS3-4818072M | 206.66 | KT3-4818072M | 163.99 | KX3-4818M | 60.66 |
| 18" x 72" | 2" | 1,200 | KS2-7218072M | 262.62 | KT2-7218072M | 219.95 | KX2-7218M | 88.64 |
| 18" x 72" | 3" | 1,800 | KS3-7218072M | 282.30 | KT3-7218072M | 239.63 | KX3-7218M | 98.48 |
| 18" x 96" | 2" | 1,000 | KS2-9618072M | 294.74 | KT2-9618072M | 252.07 | KX2-9618M | 104.70 |
| 18" x 96" | 3" | 1,600 | KS3-9618072M | 321.02 | KT3-9618072M | 278.35 | KX3-9618M | 117.84 |
| 24" x 48" | 2" | 1,400 | KS2-4824072M | 203.86 | KT2-4824072M | 158.42 | KX2-4824M | 56.49 |
| 24" x 48" | 3" | 2,000 | KS3-4824072M | 216.98 | KT3-4824072M | 171.54 | KX3-4824M | 63.05 |
| 24" x 72" | 2" | 1,200 | KS2-7224072M | 276.40 | KT2-7224072M | 230.96 | KX2-7224M | 92.76 |
| 24" x 72" | 3" | 1,800 | KS3-7224072M | 296.08 | KT3-7224072M | 250.64 | KX3-7224M | 102.60 |
| 24" x 96" | 2" | 1,000 | KS2-9624072M | 309.84 | KT2-9624072M | 264.40 | KX2-9624M | 109.48 |
| 24" x 96" | 3" | 1,600 | KS3-9624072M | 336.12 | KT3-9624072M | 290.68 | KX3-9624M | 122.62 |
| 36" x 48" | 2" | 1,400 | KS2-4836072M | 230.82 | KT2-4836072M | 176.70 | KX2-4836M | 61.29 |
| 36" x 48" | 3" | 2,000 | KS3-4836072M | 243.94 | KT3-4836072M | 189.82 | KX3-4836M | 67.85 |
| 36" x 72" | 2" | 1,200 | KS2-7236072M | 310.48 | KT2-7236072M | 256.36 | KX2-7236M | 101.12 |
| 36" x 72" | 3" | 1,800 | KS3-7236072M | 330.16 | KT3-7236072M | 276.04 | KX3-7236M | 110.96 |
| 36" x 96" | 2" | 1,000 | KS2-9636072M | 346.40 | KT2-9636072M | 292.28 | KX2-9636M | 119.08 |
| 36" x 96" | 3" | 1,600 | KS3-9636072M | 372.68 | KT3-9636072M | 318.56 | KX3-9636M | 132.22 |
| 48" x 48" | 2" | 1,400 | KS2-4848072M | 258.22 | KT2-4848072M | 195.42 | KX2-4848M | 66.31 |
| 48" x 48" | 3" | 2,000 | KS3-4848072M | 271.34 | KT3-4848072M | 208.54 | KX3-4848M | 72.87 |
| 48" x 72" | 2" | 1,200 | KS2-7248072M | 342.40 | KT2-7248072M | 279.60 | KX2-7248M | 108.40 |
| 48" x 72" | 3" | 1,800 | KS3-7248072M | 362.08 | KT3-7248072M | 299.28 | KX3-7248M | 118.24 |
| 48" x 96" | 2" | 1,000 | KS2-9648072M | 383.84 | KT2-9648072M | 321.04 | KX2-9648M | 129.12 |
| 48" x 96" | 3" | 1,600 | KS3-9648072M | 410.12 | KT3-9648072M | 347.32 | KX3-9648M | 142.26 |
| 8' HIGH UNITS | | | | | | | Extra Shelf | |
| 18" x 48" | 2" | 1,400 | KS2-4818096M | 212.68 | KT2-4818096M | 160.44 | KX2-4818M | 54.10 |
| 18" x 48" | 3" | 2,000 | KS3-4818096M | 225.80 | KT3-4818096M | 173.56 | KX3-4818M | 60.66 |
| 18" x 72" | 2" | 1,200 | KS2-7218096M | 281.76 | KT2-7218096M | 229.52 | KX2-7218M | 88.64 |
| 18" x 72" | 3" | 1,800 | KS3-7218096M | 301.44 | KT3-7218096M | 249.20 | KX3-7218M | 98.48 |
| 18" x 96" | 2" | 1,000 | KS2-9618096M | 313.88 | KT2-9618096M | 261.64 | KX2-9618M | 104.70 |
| 18" x 96" | 3" | 1,600 | KS3-9618096M | 340.16 | KT3-9618096M | 287.92 | KX3-9618M | 117.84 |
| 24" x 48" | 2" | 1,400 | KS2-4824096M | 222.92 | KT2-4824096M | 167.95 | KX2-4824M | 56.49 |
| 24" x 48" | 3" | 2,000 | KS3-4824096M | 236.04 | KT3-4824096M | 181.07 | KX3-4824M | 63.05 |
| 24" x 72" | 2" | 1,200 | KS2-7224096M | 295.46 | KT2-7224096M | 240.49 | KX2-7224M | 92.76 |
| 24" x 72" | 3" | 1,800 | KS3-7224096M | 315.14 | KT3-7224096M | 260.17 | KX3-7224M | 102.60 |
| 24" x 96" | 2" | 1,000 | KS2-9624096M | 328.90 | KT2-9624096M | 273.93 | KX2-9624M | 109.48 |
| 24" x 96" | 3" | 1,600 | KS3-9624096M | 355.18 | KT3-9624096M | 300.21 | KX3-9624M | 122.62 |
| 36" x 48" | 2" | 1,400 | KS2-4836096M | 249.88 | KT2-4836096M | 186.23 | KX2-4836M | 61.29 |
| 36" x 48" | 3" | 2,000 | KS3-4836096M | 263.00 | KT3-4836096M | 199.35 | KX3-4836M | 67.85 |
| 36" x 72" | 2" | 1,200 | KS2-7236096M | 329.54 | KT2-7236096M | 265.89 | KX2-7236M | 101.12 |
| 36" x 72" | 3" | 1,800 | KS3-7236096M | 349.22 | KT3-7236096M | 285.57 | KX3-7236M | 110.96 |
| 36" x 96" | 2" | 1,000 | KS2-9636096M | 365.46 | KT2-9636096M | 301.81 | KX2-9636M | 119.08 |
| 36" x 96" | 3" | 1,600 | KS3-9636096M | 391.74 | KT3-9636096M | 328.09 | KX3-9636M | 132.22 |
| 48" x 48" | 2" | 1,400 | KS2-4848096M | 277.30 | KT2-4848096M | 204.96 | KX2-4848M | 66.31 |
| 48" x 48" | 3" | 2,000 | KS3-4848096M | 290.42 | KT3-4848096M | 218.08 | KX3-4848M | 72.87 |
| 48" x 72" | 2" | 1,200 | KS2-7248096M | 361.48 | KT2-7248096M | 289.14 | KX2-7248M | 108.40 |
| 48" x 72" | 3" | 1,800 | KS3-7248096M | 381.16 | KT3-7248096M | 308.82 | KX3-7248M | 118.24 |
| 48" x 96" | 2" | 1,000 | KS2-9648096M | 402.92 | KT2-9648096M | 330.58 | KX2-9648M | 129.12 |
| 48" x 96" | 3" | 1,600 | KS3-9648096M | 429.20 | KT3-9648096M | 356.86 | KX3-9648M | 142.26 |

These complete units (pages 10-11) are priced to include high capacity wire mesh decking that features a waterfall design so that wire mesh curves over top of beams to provide a smooth shelf surface. Priced as 2 shelf units that can be set-up so that goods can be stored on floor. Choose between 6', 8', 10' or 12' tall units. Extra shelf pricing to right of the tables. Uprights can be shipped pre-assembled for an additional charge. Units with wire mesh decking are available on pages 10-11.

When placing an order, please use "M" for wire mesh decking at the end of the model number.



Model Number Code: KS2-4818072M

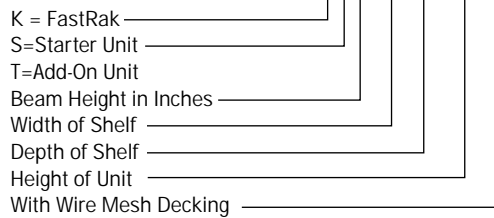

Anchor uprights to concrete floors with footplates and anchors (See page 7)

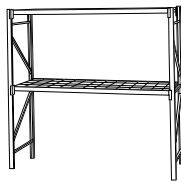

Starter Unit

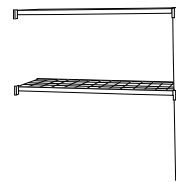

Add-On Unit



| Size W x D | Beam H | Shelf Cap. | Model Number | Price Each | Model Number | Price Each | Model Number | Price Each |
|------------|--------|------------|-----------------------|------------|--------------|--------------------|--------------|------------|
| | | | 10' HIGH UNITS | | | Extra Shelf | | |
| 18" x 48" | 2" | 1,400 | KS2-4818120M | 238.64 | KT2-4818120M | 173.42 | KX2-4818M | 54.10 |
| 18" x 48" | 3" | 2,000 | KS3-4818120M | 251.76 | KT3-4818120M | 186.54 | KX3-4818M | 60.66 |
| 18" x 72" | 2" | 1,200 | KS2-7218120M | 307.72 | KT2-7218120M | 242.50 | KX2-7218M | 88.64 |
| 18" x 72" | 3" | 1,800 | KS3-7218120M | 327.40 | KT3-7218120M | 262.18 | KX3-7218M | 98.48 |
| 18" x 96" | 2" | 1,000 | KS2-9618120M | 339.84 | KT2-9618120M | 274.62 | KX2-9618M | 104.70 |
| 18" x 96" | 3" | 1,600 | KS3-9618120M | 366.12 | KT3-9618120M | 300.90 | KX3-9618M | 117.84 |
| 24" x 48" | 2" | 1,400 | KS2-4824120M | 268.40 | KT2-4824120M | 180.87 | KX2-4824M | 56.49 |
| 24" x 48" | 3" | 2,000 | KS3-4824120M | 261.88 | KT3-4824120M | 193.99 | KX3-4824M | 63.05 |
| 24" x 72" | 2" | 1,200 | KS2-7224120M | 321.30 | KT2-7224120M | 253.41 | KX2-7224M | 92.76 |
| 24" x 72" | 3" | 1,800 | KS3-7224120M | 340.98 | KT3-7224120M | 273.09 | KX3-7224M | 102.60 |
| 24" x 96" | 2" | 1,000 | KS2-9624120M | 354.74 | KT2-9624120M | 286.85 | KX2-9624M | 109.48 |
| 24" x 96" | 3" | 1,600 | KS3-9624120M | 381.02 | KT3-9624120M | 313.13 | KX3-9624M | 122.62 |
| 36" x 48" | 2" | 1,400 | KS2-4836120M | 268.94 | KT2-4836120M | 195.76 | KX2-4836M | 61.29 |
| 36" x 48" | 3" | 2,000 | KS3-4836120M | 282.06 | KT3-4836120M | 208.88 | KX3-4836M | 67.85 |
| 36" x 72" | 2" | 1,200 | KS2-7236120M | 348.60 | KT2-7236120M | 275.42 | KX2-7236M | 101.12 |
| 36" x 72" | 3" | 1,800 | KS3-7236120M | 368.28 | KT3-7236120M | 295.10 | KX3-7236M | 110.96 |
| 36" x 96" | 2" | 1,000 | KS2-9636120M | 384.52 | KT2-9636120M | 311.34 | KX2-9636M | 119.08 |
| 36" x 96" | 3" | 1,600 | KS3-9636120M | 410.80 | KT3-9636120M | 337.62 | KX3-9636M | 132.22 |
| 48" x 48" | 2" | 1,400 | KS2-4848120M | 296.36 | KT2-4848120M | 214.49 | KX2-4848M | 66.31 |
| 48" x 48" | 3" | 2,000 | KS3-4848120M | 309.48 | KT3-4848120M | 227.61 | KX3-4848M | 72.87 |
| 48" x 72" | 2" | 1,200 | KS2-7248120M | 380.54 | KT2-7248120M | 298.67 | KX2-7248M | 108.40 |
| 48" x 72" | 3" | 1,800 | KS3-7248120M | 400.22 | KT3-7248120M | 318.35 | KX3-7248M | 118.24 |
| 48" x 96" | 2" | 1,000 | KS2-9648120M | 421.98 | KT2-9648120M | 340.11 | KX2-9648M | 129.12 |
| 48" x 96" | 3" | 1,600 | KS3-9648120M | 448.26 | KT3-9648120M | 366.39 | KX3-9648M | 142.26 |
| | | | 12' HIGH UNITS | | | Extra Shelf | | |
| 36" x 48" | 2" | 1,400 | KS2-4836144M | 288.00 | KT2-4836144M | 215.33 | KX2-4836M | 61.29 |
| 36" x 48" | 3" | 2,000 | KS3-4836144M | 301.12 | KT3-4836144M | 228.45 | KX3-4836M | 67.85 |
| 36" x 72" | 2" | 1,200 | KS2-7236144M | 367.66 | KT2-7236144M | 284.95 | KX2-7236M | 101.12 |
| 36" x 72" | 3" | 1,800 | KS3-7236144M | 387.34 | KT3-7236144M | 304.63 | KX3-7236M | 110.96 |
| 36" x 96" | 2" | 1,000 | KS2-9636144M | 403.58 | KT2-9636144M | 386.81 | KX2-9636M | 119.08 |
| 36" x 96" | 3" | 1,600 | KS3-9636144M | 429.86 | KT3-9636144M | 413.09 | KX3-9636M | 132.22 |
| 48" x 48" | 2" | 1,400 | KS2-4848144M | 315.44 | KT2-4848144M | 224.03 | KX2-4848M | 66.31 |
| 48" x 48" | 3" | 2,000 | KS3-4848144M | 328.56 | KT3-4848144M | 237.15 | KX3-4848M | 72.87 |
| 48" x 72" | 2" | 1,200 | KS2-7248144M | 399.62 | KT2-7248144M | 308.21 | KX2-7248M | 108.40 |
| 48" x 72" | 3" | 1,800 | KS3-7248144M | 419.30 | KT3-7248144M | 327.89 | KX3-7248M | 118.24 |
| 48" x 96" | 2" | 1,000 | KS2-9648144M | 441.06 | KT2-9648144M | 349.65 | KX2-9648M | 129.12 |
| 48" x 96" | 3" | 1,600 | KS3-9648144M | 543.32 | KT3-9648144M | 451.91 | KX3-9648M | 142.26 |

FastRak Archive Storage Units

Made from the industrial strength FastRak, these archive storage racks are built to hold even your heaviest archive boxes. Featuring heavy duty uprights with a bolt together design that has the advantage of component replacement in case of damage. Each level will hold 1,600 lbs. Units are designed to accommodate either 15" deep or 24" deep archive boxes and are priced with or without boxes. Single depth and double box depth configurations are also available. Units priced with unassembled uprights. Assembled uprights available for an additional cost.



Archive File Boxes



225-SF1 – 15" Deep Archive Boxes – \$4.75 ea.
 These rugged 200 lbs. corrugated boxes are ideal for storing documents. Boxes can accommodate either letter size or legal size records. Sold 10 per bundle. Priced per box.
 Size: 15"D x 12"W x 11"H Color: White

225-SF2 – 24" Deep Archive Boxes – \$7.12 ea.
 Double walled panels and reinforced handles provide added strength and durability. Tight fitting lid adds rigidity and can be removed for easy access to records. Sold 10 per bundle. Priced per box
 Size: 24"D x 12"W x 11"H Color: White

| Size W x D x H | # of Levels | Box Cap. | Starter Units w/o Boxes | | Starter Units with Boxes | | Add-On Units w/o Boxes | | Add-On Units with Boxes | |
|--|-------------|----------|-------------------------|------------|--------------------------|------------|------------------------|------------|-------------------------|------------|
| | | | Model Number | Price Each | Model Number | Price Each | Model Number | Price Each | Model Number | Price Each |
| Single Box Depth - 15" Deep Boxes | | | | | | | | | | |
| 48" x 18" x 96" | 4 | 24 | K34S-4818096W | 285.96 | K34S-4818096WS | 399.96 | K34T-4818096W | 233.72 | K34T-4818096WS | 347.72 |
| 72" x 18" x 96" | 4 | 40 | K34S-7218096W | 369.60 | K34S-7218096WS | 559.60 | K34T-7218096W | 317.36 | K34T-7218096WS | 507.36 |
| 96" x 18" x 96" | 4 | 56 | K34S-9618096W | 453.48 | K34S-9618096WS | 719.48 | K34T-9618096W | 401.24 | K34T-9618096WS | 667.24 |
| 48" x 18" x 120" | 5 | 30 | K35S-4818120W | 357.29 | K35S-4818120WS | 499.79 | K35T-4818120W | 292.07 | K35T-4818120WS | 434.57 |
| 72" x 18" x 120" | 5 | 50 | K35S-7218120W | 461.84 | K35S-7218120WS | 699.34 | K35T-7218120W | 396.62 | K35T-7218120WS | 634.12 |
| 96" x 18" x 120" | 5 | 70 | K35S-9618120W | 566.69 | K35S-9618120WS | 899.19 | K35T-9618120W | 501.47 | K35T-9618120WS | 833.97 |
| Double Box Depth - 15" Deep Boxes | | | | | | | | | | |
| 48" x 36" x 96" | 4 | 48 | K34S-4836096W | 387.58 | K34S-4836096WS | 615.58 | K34T-4836096W | 323.93 | K34T-4836096WS | 551.93 |
| 72" x 36" x 96" | 4 | 80 | K34S-7236096W | 510.66 | K34S-7236096WS | 890.66 | K34T-7236096W | 447.01 | K34T-7236096WS | 827.01 |
| 96" x 36" x 96" | 4 | 112 | K34S-9636096W | 633.90 | K34S-9636096WS | 1165.90 | K34T-9636096W | 570.25 | K34T-9636096WS | 1102.25 |
| 48" x 36" x 120" | 5 | 60 | K35S-4836120W | 471.71 | K35S-4836120WS | 756.71 | K35T-4836120W | 398.53 | K35T-4836120WS | 683.53 |
| 72" x 36" x 120" | 5 | 100 | K35S-7236120W | 625.56 | K35S-7236120WS | 1100.56 | K35T-7236120W | 552.38 | K35T-7236120WS | 1027.38 |
| 96" x 36" x 120" | 5 | 140 | K35S-9636120W | 779.61 | K35S-9636120WS | 1444.61 | K35T-9636120W | 706.43 | K35T-9636120WS | 1371.43 |

| Size W x D x H | # of Levels | Box Cap. | Starter Units w/o Boxes | | Starter Units with Boxes | | Add-On Units w/o Boxes | | Add-On Units with Boxes | |
|--|-------------|----------|-------------------------|------------|--------------------------|------------|------------------------|------------|-------------------------|------------|
| | | | Model Number | Price Each | Model Number | Price Each | Model Number | Price Each | Model Number | Price Each |
| Single Box Depth - 24" Deep Boxes | | | | | | | | | | |
| 48" x 24" x 96" | 4 | 24 | K34S-4824096W | 329.98 | K34S-4824096WS | 500.86 | K34T-4824096W | 275.01 | K34T-4824096WS | 445.89 |
| 72" x 24" x 96" | 4 | 40 | K34S-7224096W | 433.02 | K34S-7224096WS | 717.82 | K34T-7224096W | 378.05 | K34T-7224096WS | 662.85 |
| 96" x 24" x 96" | 4 | 56 | K34S-9624096W | 536.18 | K34S-9624096WS | 934.90 | K34T-9624096W | 481.21 | K34T-9624096WS | 879.93 |
| 48" x 24" x 120" | 5 | 30 | K35S-4824120W | 410.83 | K35S-4824120WS | 624.43 | K35T-4824120W | 342.94 | K35T-4824120WS | 556.54 |
| 72" x 24" x 120" | 5 | 50 | K35S-7224120W | 539.63 | K35S-7224120WS | 895.63 | K35T-7224120W | 471.74 | K35T-7224120WS | 827.74 |
| 96" x 24" x 120" | 5 | 70 | K35S-9624120W | 668.58 | K35S-9624120WS | 1166.98 | K35T-9624120W | 600.69 | K35T-9624120WS | 1099.09 |
| Single Box Depth - 24" Deep Boxes | | | | | | | | | | |
| 48" x 48" x 96" | 4 | 24 | K34S-4848096W | 444.68 | K34S-4848096WS | 786.44 | K34T-4848096W | 372.34 | K34T-4848096WS | 714.10 |
| 72" x 48" x 96" | 4 | 40 | K34S-7248096W | 587.60 | K34S-7248096WS | 1157.20 | K34T-7248096W | 515.26 | K34T-7248096WS | 1084.86 |
| 96" x 48" x 96" | 4 | 56 | K34S-9648096W | 730.72 | K34S-9648096WS | 1528.16 | K34T-9648096W | 658.38 | K34T-9648096WS | 1455.82 |
| 48" x 48" x 120" | 5 | 30 | K35S-4848120W | 468.79 | K35S-4848120WS | 895.99 | K35T-4848120W | 386.92 | K35T-4848120WS | 814.12 |
| 72" x 48" x 120" | 5 | 50 | K35S-7248120W | 717.39 | K35S-7248120WS | 1429.39 | K35T-7248120W | 635.52 | K35T-7248120WS | 1347.52 |
| 96" x 48" x 120" | 5 | 70 | K35S-9648120W | 896.29 | K35S-9648120WS | 1893.09 | K35T-9648120W | 814.42 | K35T-9648120WS | 1811.22 |

Black Z-Beam Shelving

At an incredible value, this unique Z-Beam design provides maximum storage capacity with easy assembly. Z-Beams allow for particle board decking to sit flush with the top of the beams for a more attractive look. Units come complete with 5 shelves and particle board decking. You can easily customize this unit by adding extra shelves. Extra shelf pricing located below. Steel color: Black.



| 5 Shelf Units | | | | Extra Shelves | |
|-----------------|------------|--------------|------------|---------------|------------|
| Size W x D x H | Shelf Cap. | Model Number | Price Each | Model Number | Price Each |
| 36" x 12" x 72" | 500 | L5-3612-72W | 98.33 | LX1-3612-W | 13.93 |
| 36" x 18" x 72" | 500 | L5-3618-72W | 112.98 | LX1-3618-W | 16.86 |
| 36" x 24" x 72" | 500 | L5-3624-72W | 128.33 | LX1-3624-W | 19.93 |
| 48" x 12" x 72" | 500 | L5-4812-72W | 115.38 | LX1-4812-W | 17.34 |
| 48" x 18" x 72" | 500 | L5-4818-72W | 133.13 | LX1-4818-W | 20.89 |
| 48" x 24" x 72" | 500 | L5-4824-72W | 151.58 | LX1-4824-W | 24.58 |

Boltless Modular Shelving

Featuring a split post design that allows you to economically create the storage system or workcenter you need. Unit is a completely packaged set that is securely packaged and allows for easy shipment. Units are 72"H or split into separate 36"H workbenches. Assembles in minutes without nuts, bolts or shelf clips. Unit features 5 shelves that complete with particle board decking. Steel color: Gray. Unit capacity: 4,000 lbs.

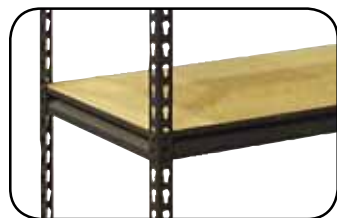

| Size W x D x H | Shelf Cap. | Model Number | Price Each |
|-----------------|------------|--------------|------------|
| 36" x 18" x 72" | 800 | 200-XR1505 | 119.41 |
| 48" x 24" x 72" | 800 | 200-XR2505 | 165.60 |

Bulk Storage Shelving

- » Commercial grade 16 gauge steel frame with 5/8" particle board decking
- » Heavy-duty shelves hold up to 750 lbs. per shelf
- » Unit is completely packaged & ready for quick-shipment
- » Steel components feature a durable black powder coated finish
- » Complete with 3 shelves
- » Easy to assemble



| Size W x D x H | Shelf Cap. | Model Number | Price Each |
|-----------------|------------|--------------|------------|
| 72" x 18" x 72" | 750 | 215-XP7218 | 194.16 |

Chrome Wire Shelving Units

Unlike other wire shelving on the market, our wire shelving is certified by National Sanitation Foundation International. High quality chrome finish is very attractive and durable. Open wire construction reduces dust build-up, allows free light and air circulation, increases sprinkler effectiveness and improves visibility. Fast and easy to assemble. No tools required for assembly. Each shelf is adjustable in 1" increments. Units priced with 4 shelves and available in 63", 74" and 86" heights.

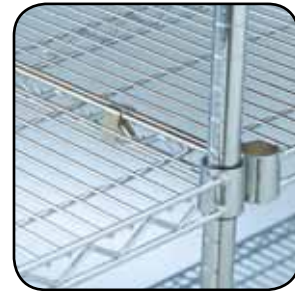

Add-On Units can be added using S-Hooks to create even shelf additions



Utilize common posts to connect multiple units

| Shelf Size | Shelf Cap. | 63" High | | 74" High | | 86" High | | Model Number | Price Each |
|------------------------------|------------|--------------|------------|--------------|------------|--------------|------------|--------------|--------------------|
| | | Model Number | Price Each | Model Number | Price Each | Model Number | Price Each | | |
| 4-Shelf Starter Units | | | | | | | | | Extra Shelf |
| 18" x 36" | 500 | WCS4-1836-63 | 177.52 | WCS4-1836-74 | 185.24 | WCS4-1836-86 | 195.25 | 205-CS1836 | 31.44 |
| 18" x 48" | 500 | WCS4-1848-63 | 214.00 | WCS4-1848-74 | 222.09 | WCS4-1848-86 | 232.10 | 205-CS1848 | 40.66 |
| 18" x 60" | 400 | WCS4-1860-63 | 241.95 | WCS4-1860-74 | 249.66 | WCS4-1860-86 | 259.68 | 205-CS1860 | 47.55 |
| 18" x 72" | 400 | WCS4-1872-63 | 272.67 | WCS4-1872-74 | 280.38 | WCS4-1872-86 | 290.40 | 205-CS1872 | 55.23 |
| 24" x 36" | 500 | WCS4-2436-63 | 211.31 | WCS4-2436-74 | 219.03 | WCS4-2436-86 | 229.04 | 205-CS2436 | 39.89 |
| 24" x 48" | 500 | WCS4-2448-63 | 245.04 | WCS4-2448-74 | 252.77 | WCS4-2448-86 | 262.78 | 205-CS2448 | 48.33 |
| 24" x 60" | 400 | WCS4-2460-63 | 291.07 | WCS4-2460-74 | 298.79 | WCS4-2460-86 | 308.80 | 205-CS2460 | 59.83 |
| 24" x 72" | 400 | WCS4-2472-63 | 334.03 | WCS4-2472-74 | 341.75 | WCS4-2472-86 | 351.76 | 205-CS2472 | 70.57 |
| 36" x 48" | 500 | WCS4-3648-63 | 403.02 | WCS4-3648-74 | 410.73 | WCS4-3648-86 | 420.75 | 205-CS3648 | 87.83 |
| 36" x 60" | 400 | WCS4-3660-63 | 488.64 | WCS4-3660-74 | 496.36 | WCS4-3660-86 | 506.38 | 205-CS3660 | 109.23 |
| 36" x 72" | 300 | WCS4-3672-63 | 541.07 | WCS4-3672-74 | 548.78 | WCS4-3672-86 | 558.80 | 205-CS3672 | 122.33 |
| 4-Shelf Add-On Units | | | | | | | | | Extra Shelf |
| 18" x 36" | 500 | WCT4-1836-86 | 160.71 | WCT4-1836-74 | 155.51 | WCT4-1836-86 | 160.71 | 205-CS1836 | 31.44 |
| 18" x 48" | 500 | WCT4-1848-63 | 188.49 | WCT4-1848-74 | 192.36 | WCT4-1848-86 | 197.37 | 205-CS1848 | 40.66 |
| 18" x 60" | 400 | WCT4-1860-63 | 216.07 | WCT4-1860-74 | 219.93 | WCT4-1860-86 | 224.94 | 205-CS1860 | 47.55 |
| 18" x 72" | 400 | WCT4-1872-63 | 246.81 | WCT4-1872-74 | 250.66 | WCT4-1872-86 | 255.67 | 205-CS1872 | 55.23 |
| 24" x 36" | 500 | WCT4-2436-63 | 185.44 | WCT4-2436-74 | 189.29 | WCT4-2436-86 | 194.30 | 205-CS2436 | 39.89 |
| 24" x 48" | 500 | WCT4-2448-63 | 219.17 | WCT4-2448-74 | 223.03 | WCT4-2448-86 | 228.04 | 205-CS2448 | 48.33 |
| 24" x 60" | 400 | WCT4-2460-63 | 265.20 | WCT4-2460-74 | 269.05 | WCT4-2460-86 | 274.06 | 205-CS2460 | 59.83 |
| 24" x 72" | 400 | WCT4-2472-63 | 308.15 | WCT4-2472-74 | 312.02 | WCT4-2472-86 | 317.03 | 205-CS2472 | 70.57 |
| 36" x 48" | 500 | WCT4-3648-63 | 377.13 | WCT4-3648-74 | 381.01 | WCT4-3648-86 | 386.01 | 205-CS3648 | 87.83 |
| 36" x 60" | 400 | WCT4-3660-63 | 462.76 | WCT4-3660-74 | 466.64 | WCT4-3660-86 | 471.65 | 205-CS3660 | 109.23 |
| 36" x 72" | 300 | WCT4-3672-63 | 515.19 | WCT4-3672-74 | 519.06 | WCT4-3672-86 | 524.06 | 205-CS3672 | 122.33 |

Chrome Plated Mobile Carts

These mobile wire carts are constructed to the highest quality standards and feature rust resistant chrome plating. Attractive open wire design reduces dust build-up and improves light and air circulation. Carts are highly maneuverable and come standard with 5" diameter swivel locking caster wheels. Fast and easy to assemble. No special tools are required. Shelves are fully adjustable in 1" increments. Cart capacity: 600 lbs. Available in 69" and 80" high mobile units that include 4 shelves.



Increase unit functionality by adding useful accessories (see below)



Featuring 5" casters with locking brakes.



| | | 69" High | | 80" High | | | |
|------------------------------|------------|--------------|------------|--------------------|------------|--------------|------------|
| Shelf Size | Shelf Cap. | Model Number | Price Each | Model Number | Price Each | Model Number | Price Each |
| 4 Shelf Starter Units | | | | Extra Shelf | | | |
| 18" x 36" | 500 | WCC4-1836-63 | 234.52 | WCC4-1836-74 | 242.23 | 205-CS1836 | 31.44 |
| 18" x 48" | 500 | WCC4-1848-63 | 271.36 | WCC4-1848-74 | 279.07 | 205-CS1848 | 40.66 |
| 18" x 60" | 400 | WCC4-1860-63 | 298.93 | WCC4-1860-74 | 306.63 | 205-CS1860 | 47.55 |
| 18" x 72" | 400 | WCC4-1872-63 | 329.66 | WCC4-1872-74 | 337.36 | 205-CS1872 | 55.23 |
| 24" x 36" | 500 | WCC4-2436-63 | 268.30 | WCC4-2436-74 | 276.01 | 205-CS2436 | 39.89 |
| 24" x 48" | 500 | WCC4-2448-63 | 301.55 | WCC4-2448-74 | 309.25 | 205-CS2448 | 48.33 |
| 24" x 60" | 400 | WCC4-2460-63 | 348.06 | WCC4-2460-74 | 355.76 | 205-CS2460 | 59.83 |
| 24" x 72" | 400 | WCC4-2472-63 | 391.02 | WCC4-2472-74 | 398.72 | 205-CS2472 | 70.57 |
| 36" x 48" | 500 | WCC4-3648-63 | 459.99 | WCC4-3648-74 | 467.70 | 205-CS3648 | 87.83 |
| 36" x 60" | 400 | WCC4-3660-63 | 545.63 | WCC4-3660-74 | 553.33 | 205-CS3660 | 109.23 |
| 36" x 72" | 300 | WCC4-3672-63 | 598.07 | WCC4-3672-74 | 605.77 | 205-CS3672 | 122.33 |

Chrome Plated Service Carts

Highly functional service carts that are available in 2 or 3 shelf configurations. Carts are 38½" high with a capacity of 600 lbs.



| | | 2 Shelf Carts | | 3 Shelf Carts | |
|------------|------------|---------------|------------|---------------|------------|
| Shelf Size | Shelf Cap. | Model Number | Price Each | Model Number | Price Each |
| 18" x 36" | 500 | WCD2-1836 | 161.41 | WCD3-1836 | 192.85 |
| 18" x 48" | 500 | WCD2-1848 | 179.82 | WCD3-1848 | 220.48 |
| 18" x 60" | 400 | WCD2-1860 | 193.62 | WCD3-1860 | 241.17 |
| 18" x 72" | 400 | WCD2-1872 | 208.98 | WCD3-1872 | 264.22 |
| 24" x 36" | 500 | WCD2-2436 | 183.11 | WCD3-2436 | 223.00 |
| 24" x 48" | 500 | WCD2-2448 | 199.97 | WCD3-2448 | 248.30 |
| 24" x 60" | 400 | WCD2-2460 | 222.99 | WCD3-2460 | 282.81 |
| 24" x 72" | 400 | WCD2-2472 | 244.46 | WCD3-2472 | 315.04 |

Chrome Accessories

You can increase the functionality of new or pre-owned units with our accessories that are interchangeable with most other major brands.

| Size | Model Number | Price Each |
|---|--------------|------------|
| (A) Chrome Shelf Dividers | | |
| 18" | 205-CSD18 | 11.65 |
| 24" | 205-CSD24 | 15.54 |
| (B) Chrome Cantilever Shelves | | |
| 12" x 36" | 205-CSC1236 | 19.25 |
| 12" x 48" | 205-CSC1248 | 24.97 |
| 12" x 60" | 205-CSC1260 | 28.90 |
| (C) Chrome Ledges | | |
| 18" | 205-CL18 | 3.96 |
| 24" | 205-CL24 | 4.98 |
| 36" | 205-CL36 | 7.14 |
| 48" | 205-CL48 | 8.63 |
| 60" | 205-CL60 | 10.27 |
| (D) Chrome Safety Handles | | |
| 18" | 205-CSF18 | 12.63 |
| 24" | 205-CSF24 | 14.56 |
| 36" | 205-CSF36 | 17.23 |
| (E) Chrome U-Shaped Posts for Mobile Units | | |
| 18" | 205-CH18 | 20.14 |
| 24" | 205-CH24 | 22.53 |
| (F) Chrome Document Holder | | |
| n/a | 205-CDH | 17.97 |



(A)



(B)



(C)



(D)



(E)



(F)

Black Powder Coated Wire Shelving

Black powder coated wire shelving is made to the same high quality standards as our chrome wire shelving, but is substantially less expensive. The powder coated finish is rust and chip resistant offering a high level of durability. Wire shelving is highly attractive and functional. Wire design reduces dust build-up, improves visibility and increases sprinkler effectiveness.

Wire shelving units are very easy to assemble and do not require any special tools. Units can be assembled in less than 10 minutes. Shelves are fully adjustable in 1" increments. Posts include adjustable feet to accommodate uneven floors.

Units are available in 63", 74" and 86" heights and include 4 shelves



Add-On Units can be added using **S-Hooks** to create even shelf additions



Utilize common posts to connect **multiple units**



| Shelf Size | Shelf Cap. | 63" High | | 74" High | | 86" High | | Model Number | Price Each | |
|------------------------------|------------|---------------------|------------|---------------------|------------|---------------------|------------|-------------------|--------------------|--|
| | | Model Number | Price Each | Model Number | Price Each | Model Number | Price Each | | | |
| 4-Shelf Starter Units | | | | | | | | | Extra Shelf | |
| 18" x 36" | 500 | WBS4-1836-63 | 147.06 | WBS4-1836-74 | 149.41 | WBS4-1836-86 | 157.29 | 205-BS1836 | 26.42 | |
| 18" x 48" | 400 | WBS4-1848-63 | 168.91 | WBS4-1848-74 | 171.26 | WBS4-1848-86 | 179.14 | 205-BS1848 | 31.89 | |
| 18" x 60" | 300 | WBS4-1860-63 | 216.14 | WBS4-1860-74 | 218.49 | WBS4-1860-86 | 226.37 | 205-BS1860 | 43.69 | |
| 18" x 72" | 300 | WBS4-1872-63 | 244.88 | WBS4-1872-74 | 247.23 | WBS4-1872-86 | 255.11 | 205-BS1872 | 50.87 | |
| 24" x 36" | 500 | WBS4-2436-63 | 174.39 | WBS4-2436-74 | 176.74 | WBS4-2436-86 | 184.62 | 205-BS2436 | 33.26 | |
| 24" x 48" | 400 | WBS4-2448-63 | 205.37 | WBS4-2448-74 | 207.72 | WBS4-2448-86 | 215.59 | 205-BS2448 | 40.99 | |
| 24" x 60" | 300 | WBS4-2460-63 | 258.87 | WBS4-2460-74 | 261.22 | WBS4-2460-86 | 269.09 | 205-BS2460 | 54.38 | |
| 24" x 72" | 300 | WBS4-2472-63 | 301.58 | WBS4-2472-74 | 303.93 | WBS4-2472-86 | 311.81 | 205-BS2472 | 65.05 | |
| 4-Shelf Add-On Units | | | | | | | | | Extra Shelf | |
| 18" x 36" | 500 | WBT4-1836-86 | 135.43 | WBT4-1836-74 | 127.55 | WBT4-1836-86 | 135.43 | 205-BS1836 | 26.42 | |
| 18" x 48" | 400 | WBT4-1848-63 | 147.04 | WBT4-1848-74 | 149.39 | WBT4-1848-86 | 157.27 | 205-BS1848 | 31.89 | |
| 18" x 60" | 300 | WBT4-1860-63 | 194.27 | WBT4-1860-74 | 196.62 | WBT4-1860-86 | 204.50 | 205-BS1860 | 43.69 | |
| 18" x 72" | 300 | WBT4-1872-63 | 223.01 | WBT4-1872-74 | 225.36 | WBT4-1872-86 | 233.24 | 205-BS1872 | 50.87 | |
| 24" x 36" | 500 | WBT4-2436-63 | 152.52 | WBT4-2436-74 | 154.87 | WBT4-2436-86 | 162.75 | 205-BS2436 | 33.26 | |
| 24" x 48" | 400 | WBT4-2448-63 | 183.49 | WBT4-2448-74 | 185.85 | WBT4-2448-86 | 193.72 | 205-BS2448 | 40.99 | |
| 24" x 60" | 300 | WBT4-2460-63 | 236.99 | WBT4-2460-74 | 239.35 | WBT4-2460-86 | 247.22 | 205-BS2460 | 54.38 | |
| 24" x 72" | 300 | WBT4-2472-63 | 279.71 | WBT4-2472-74 | 282.06 | WBT4-2472-86 | 289.94 | 205-BS2472 | 65.05 | |

Black Powder Coated Mobile Carts

These mobile wire shelving units are attractive and highly functional. Open wire design reduces dust build-up and improves air circulation. Carts include four 5" swivel casters. Black powder coated finish is chip and scratch resistant. Shelves are adjustable in 1" increments. Assembly is easy and does not require any special tools. Choose from cart heights of 36", 69" or 80". Cart capacity: 600 lbs. Units now include locking casters at no additional charge.



Featuring 5" casters with locking brakes.



| Shelf Size | Shelf Cap. | 36" High | | 69" High | | 80" High | | | |
|------------|------------|----------------|------------|----------------|------------|----------------|------------|--------------------|------------|
| | | Model Number | Price Each | Model Number | Price Each | Model Number | Price Each | Model Number | Price Each |
| | | 2 Shelf | | 4 Shelf | | 4 Shelf | | Extra Shelf | |
| 18" x 36" | 500 | WBC2-1836-30 | 130.76 | WBC4-1836-63 | 204.04 | WBC4-1836-74 | 206.36 | 205-BS1836 | 26.42 |
| 18" x 48" | 400 | WBC2-1848-30 | 141.70 | WBC4-1848-63 | 225.92 | WBC4-1848-74 | 228.24 | 205-BS1848 | 31.89 |
| 18" x 60" | 300 | WBC2-1860-30 | 165.30 | WBC4-1860-63 | 273.12 | WBC4-1860-74 | 275.44 | 205-BS1860 | 43.69 |
| 18" x 72" | 300 | WBC2-1872-30 | 179.66 | WBC4-1872-63 | 301.84 | WBC4-1872-74 | 304.16 | 205-BS1872 | 50.87 |
| 24" x 36" | 500 | WBC2-2436-30 | 144.44 | WBC4-2436-63 | 231.40 | WBC4-2436-74 | 233.72 | 205-BS2436 | 33.26 |
| 24" x 48" | 400 | WBC2-2448-30 | 159.90 | WBC4-2448-63 | 262.32 | WBC4-2448-74 | 264.64 | 205-BS2448 | 40.99 |
| 24" x 60" | 300 | WBC2-2460-30 | 186.68 | WBC4-2460-63 | 315.88 | WBC4-2460-74 | 318.20 | 205-BS2460 | 54.38 |
| 24" x 72" | 300 | WBC2-2472-30 | 208.02 | WBC4-2472-63 | 358.56 | WBC4-2472-74 | 360.88 | 205-BS2472 | 65.05 |

Wire Shelving Components

Wire shelving components can be purchased separately to replace lost or damaged pieces or to allow you to create your own design. You can customize new or pre-owned units with our components that are interchangeable with most other major brands.



Stationary Posts



Mobile Posts (caster not included)



Chrome Wire Shelves



Black Wire Shelves

| Height | Model Number | Price Each |
|-------------------------|--------------|------------|
| Black Posts | | |
| Stationary Posts | | |
| 36" | 205-BP36 | 5.92 |
| 63" | 205-BP63 | 10.35 |
| 74" | 205-BP74 | 10.94 |
| 86" | 205-BP86 | 12.90 |
| Mobile Posts | | |
| 36" | 205-BP30M | 4.92 |
| 63" | 205-BP63M | 10.03 |
| 74" | 205-BP74M | 10.61 |

| Height | Model Number | Price Each |
|-------------------------|--------------|------------|
| Chrome Posts | | |
| Stationary Posts | | |
| 63" | 205-CP63 | 12.94 |
| 74" | 205-CP74 | 14.87 |
| 86" | 205-CP86 | 17.38 |
| Mobile Posts | | |
| 63" | 205-CP63M | 12.63 |
| 74" | 205-CP74M | 14.55 |

| D x W | Model Number | Price Each |
|-----------|--------------|------------|
| 18" x 36" | 205-CS1836 | 31.44 |
| 18" x 48" | 205-CS1848 | 40.66 |
| 18" x 60" | 205-CS1860 | 47.55 |
| 18" x 72" | 205-CS1872 | 55.23 |
| 24" x 36" | 205-CS2436 | 39.89 |
| 24" x 48" | 205-CS2448 | 48.33 |
| 24" x 60" | 205-CS2460 | 59.83 |
| 24" x 72" | 205-CS2472 | 70.57 |
| 36" x 48" | 205-CS3648 | 87.83 |
| 36" x 60" | 205-CS3660 | 109.23 |
| 36" x 72" | 205-CS3672 | 122.33 |

Snap-On Label Holders - Flexible holders fit new or existing wire shelving with 1 1/4" face. Includes laserjet/inkjet white inserts



| Length | Qty. | Model Number | Price Each |
|--------|------|--------------|------------|
| 3" | 25 | 205-CL1253 | 40.00 |
| 6" | 25 | 205-CL1256 | 69.12 |



Wire Components

| Description | Model Number | Price Each |
|------------------------------|--------------|------------|
| (A) Locking 5" Swivel Caster | 205-AC5L | 14.56 |
| (B) Chrome Post Anchor | 205-CPA | 4.49 |
| (C) Post Foot (adjustable) | 205-CPF | 1.20 |
| (D) Shelf Clip (pair) | 205-CSCLIP1 | 0.36 |
| (E) Post Mounting Bracket | 205-CPMB | 7.49 |
| (F) Chrome Post Connector | 205-CPC | 5.69 |
| Black Post Connector | 205-BPC | 5.09 |
| (G) S Style Hook for Chrome | 205-CSHOOK1 | 1.51 |
| S Style Hook for Black | 205-BSHOOK1 | 1.26 |

Pallet Rack

Regular Duty and Heavy Duty pallet rack features 3" x 3" columns and 5" x 8" seismic base plates. Regular duty uprights are constructed of 16 gauge steel and provide 16,100 lbs. capacity per upright. The heavy duty uprights feature a 23,300 lbs. capacity and are constructed from 14 gauge steel (regular and heavy duty capacities are based upon a maximum shelf spacing of 36").

The bolt together design of the pallet rack uprights provides a lower cost of ownership because components can be easily replaced when damaged during use. Traditional welded uprights would require replacement of the entire upright at a more significant cost. Step Load Beams feature a removeable safety clip that allows for easy replacement of damaged clips. Racks are designed for use with a forklift (or other hydraulic or electrical lift) or for heavy duty hand stacking. Buy pallet rack uprights, beams, wire mesh decking and accessories separately or in complete "starter" and "add-on" units.



Popular tear drop design insures interchangeability with most major pallet rack manufacturers: Interlake (Original Style), Space Rack, USP, Lodi Metal-Tech, Steek King and Husky.

Uprights

Featuring a 3" x 3" standard column design and 5" x 8" base plate. Regular duty uprights are constructed of 16 gauge steel with a 16,100 lbs. capacity. Heavy duty uprights feature 14 gauge steel construction with a capacity of 23,300 lbs. (regular and heavy duty capacities based upon 36" maximum shelf spacing). Uprights utilize a bolt together design for easy component replacement. Beams can be adjusted every 2". Uprights can be shipped assembled for an additional charge per upright. Color: Light green.

Regular Duty Upright



Heavy Duty Upright

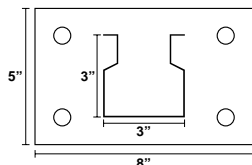
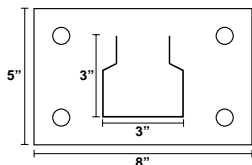

| H x D | Unassembled | | Assembled | |
|------------------------------|--------------|------------|--------------|------------|
| | Model Number | Price Each | Model Number | Price Each |
| Regular Duty Uprights | | | | |
| 8' x 3.0' | IU36096 | 80.99 | IU36096A | 89.09 |
| 10' x 3.0' | IU36120 | 95.79 | IU36120A | 105.36 |
| 12' x 3.0' | IU36144 | 118.31 | IU36144A | 130.14 |
| 8' x 3.5' | IU42096 | 85.36 | IU42096A | 93.90 |
| 10' x 3.5' | IU42120 | 100.05 | IU42120A | 110.05 |
| 12' x 3.5' | IU42144 | 124.28 | IU42144A | 136.71 |
| 8' x 4.0' | IU48096 | 89.84 | IU48096A | 98.83 |
| 10' x 4.0' | IU48120 | 104.35 | IU48120A | 114.78 |
| 12' x 4.0' | IU48144 | 130.36 | IU48144A | 143.39 |
| Heavy Duty Uprights | | | | |
| 10' x 3.0' | IUH36120 | 147.85 | IUH36120A | 162.64 |
| 12' x 3.0' | IUH36144 | 172.28 | IUH36144A | 189.51 |
| 16' x 3.0' | IUH36192 | 221.42 | IUH36192A | 243.55 |
| 10' x 3.5' | IUH42120 | 150.56 | IUH42120A | 165.61 |
| 12' x 3.5' | IUH42144 | 175.32 | IUH42144A | 192.86 |
| 16' x 3.5' | IUH42192 | 222.72 | IUH42192A | 245.00 |
| 10' x 4.0' | IUH48120 | 153.67 | IUH48120A | 169.04 |
| 12' x 4.0' | IUH48144 | 178.76 | IUH48144A | 196.64 |
| 16' x 4.0' | IUH48192 | 230.55 | IUH48192A | 253.61 |

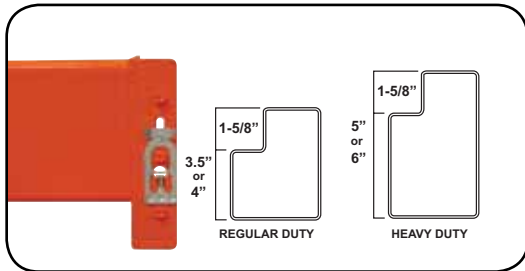

Step Load Beams

Deluxe form beams feature an improved safety clip which can be easily replaced and prevents the beam from detaching from the upright. Beams are interchangeable with most major pallet rack manufacturers. Beam length is measured by clear span between uprights. Beam capacities are based on an evenly distributed load. Sold per beam. Two beams are required to create a shelf. Color: Orange.

| H x L | Cap. Per Pair | Model Number | Price Each |
|---------------------|---------------|--------------------|------------|
| Regular Duty | | | |
| 3.5" x 8' | 3,460 | 215-IB35096 | 48.10 |
| 4.0" x 8' | 4,977 | 215-IB40096 | 52.18 |
| 4.0" x 9' | 4,228 | 215-IB40108 | 58.07 |
| 4.0" x 10' | 3,425 | 215-IB40120 | 64.00 |
| Heavy Duty | | | |
| 5.0" x 8' | 7,035 | 215-IB50096 | 59.76 |
| 5.0" x 9' | 7,103 | 215-IB50108 | 66.61 |
| 5.0" x 10' | 6,004 | 215-IB50120 | 73.44 |
| 5.0" x 12' | 4,170 | 215-IB50144 | 87.10 |
| 6.0" x 12' | 6,511 | 215-IB60144 | 110.10 |

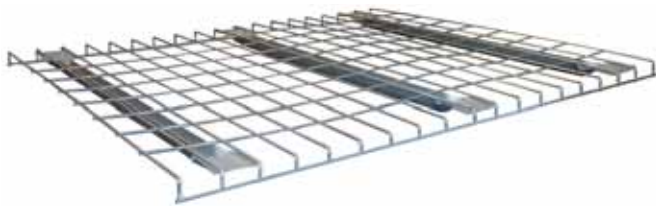

Wire Mesh Decking

Open wire construction reduces dust build-up and allows free light and air circulation, increases sprinkler effectiveness and improves visibility. Constructed of 4 gauge wire and 14 gauge flared channels. Featuring a durable powder coated finish and 2 1/2" x 4 1/2" wire spacing. Each level of decking consists of two or more smaller panels.

| D x W | Model Number | Price Each |
|-----------|-------------------|------------|
| 36" x 46" | 215-DF3646 | 27.18 |
| 36" x 58" | 215-DF3658 | 33.26 |
| 42" x 46" | 215-DF4246 | 30.22 |
| 42" x 58" | 215-DF4258 | 42.36 |
| 48" x 46" | 215-DF4846 | 36.30 |
| 48" x 58" | 215-DF4858 | 51.48 |



Bay Dividers

Organize material vertically with these easy to install bay dividers. Designed to fit over our 3.5", 4" and 5" beams. No hardware required. Pre-punched holes are available for permanent mounting.

| Model Number | Price Each |
|-----------------|------------|
| 215-ID01 | 87.69 |



Safety Supports

Use Safety Supports as front to back members to support pallets or wood decking. Steel supports are recommended for medium and heavy duty applications.

| Upright Depth | Model Number | Price Each |
|---------------|------------------|------------|
| 3.0' | 215-USS36 | 11.97 |
| 3.5' | 215-USS42 | 13.86 |
| 4.0' | 215-USS48 | 15.16 |

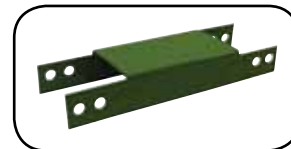

Row Spacers

Used to connect rows of pallet rack (back to back). Spacers increase stability and maintain consistent spacing between rows.

| Spacer Length | Model Number | Price Each |
|---------------|-----------------|------------|
| 6" | 215-IR06 | 6.11 |
| 12" | 215-IR12 | 9.23 |
| 18" | 215-IR18 | 12.36 |

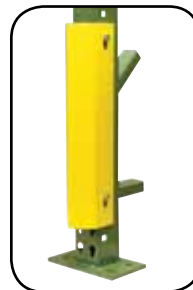

Post Frame Guards

Avoid damage to valuable rack columns. These solid steel guards withstand impacts with heavy duty construction. Features high visibility yellow powder coated finish.

| Model Number | Price Each |
|------------------|------------|
| 215-ICP24 | 33.97 |



Label Holders

Extra large for pallet rack applications. Self-adhesive or magnetic label holder allows for simple label relocation. Side loading. Includes Inkjet/Laser compatible white inserts with instructions. Bar code compatible.

| H x W | Qty. | Adhesive | | Magnetic | |
|---------|------|-----------------|------------|------------------|------------|
| | | Model Number | Price Each | Model Number | Price Each |
| 3" x 5" | 50 | 215-L335 | 61.82 | 215-L335M | 85.60 |
| 4" x 6" | 50 | 215-L346 | 73.71 | 215-L346M | 107.00 |

Regular Duty Upright Units

| Upright W x D | Beam Height | Cap. Per Pair | Starter Units | | Add-On Units | |
|-------------------------------|----------------|------------------|-----------------|---------------|-----------------|---------------|
| | | | Model Number | Price Each | Model Number | Price Each |
| Regular Duty - 8' High | | | | | | |
| 36" x 96" | 4" | 4,148 | IA36096-40096 | 386.90 | IB36096-40096 | 297.81 |
| 36" x 96" | 5" | 5,863 | IA36096-50096 | 417.22 | IB36096-50096 | 328.13 |
| 36" x 108" | 4" | 3,523 | IA36096-40108 | 410.46 | IB36096-40108 | 321.37 |
| 36" x 108" | 5" | 5,919 | IA36096-50108 | 444.62 | IB36096-50108 | 355.53 |
| 36" x 120" | 4" | 2,854 | IA36096-40120 | 434.18 | IB36096-40120 | 345.09 |
| 36" x 120" | 5" | 5,003 | IA36096-50120 | 471.94 | IB36096-50120 | 382.85 |
| 36" x 144" | 5" | 3,475 | IA36096-50144 | 526.58 | IB36096-50144 | 437.49 |
| 36" x 144" | 6" | 6,000 | IA36096-60144 | 618.58 | IB36096-60144 | 529.49 |
| 42" x 96" | 4" | 4,148 | IA42096-40096 | 396.52 | IB42096-40096 | 302.62 |
| 42" x 96" | 5" | 5,863 | IA42096-50096 | 426.84 | IB42096-50096 | 332.94 |
| 42" x 108" | 4" | 3,523 | IA42096-40108 | 420.08 | IB42096-40108 | 326.18 |
| 42" x 108" | 5" | 5,919 | IA42096-50108 | 454.24 | IB42096-50108 | 360.34 |
| 42" x 120" | 4" | 2,854 | IA42096-40120 | 443.80 | IB42096-40120 | 349.90 |
| 42" x 120" | 5" | 5,003 | IA42096-50120 | 481.56 | IB42096-50120 | 387.66 |
| 42" x 144" | 5" | 3,475 | IA42096-50144 | 536.20 | IB42096-50144 | 442.30 |
| 42" x 144" | 6" | 6,000 | IA42096-60144 | 628.20 | IB42096-60144 | 534.30 |
| 48" x 96" | 4" | 4,148 | IA48096-40096 | 406.38 | IB48096-40096 | 307.55 |
| 48" x 96" | 5" | 5,863 | IA48096-50096 | 436.70 | IB48096-50096 | 337.87 |
| 48" x 108" | 4" | 3,523 | IA48096-40108 | 429.94 | IB48096-40108 | 331.11 |
| 48" x 108" | 5" | 5,919 | IA48096-50108 | 464.10 | IB48096-50108 | 365.27 |
| 48" x 120" | 4" | 2,854 | IA48096-40120 | 453.66 | IB48096-40120 | 354.83 |
| 48" x 120" | 5" | 5,003 | IA48096-50120 | 491.42 | IB48096-50120 | 392.59 |
| 48" x 144" | 5" | 3,475 | IA48096-50144 | 546.06 | IB48096-50144 | 447.23 |
| 48" x 144" | 6" | 6,000 | IA48096-60144 | 638.06 | IB48096-60144 | 539.23 |

Pallet Rack can be ordered by component (pages 18-19) or by complete units (starter unit plus add-on units). The pricing on pages 20 - 21 are for complete pallet rack units and include two levels (four beams) per section. To add additional levels, beam pricing is on page 19.

When ordering, you need to order one starter unit per row. Subsequent units in the same row should be ordered as add-on units. Accessories, such as wire mesh decking, safety supports and row spacers are available separately (page 19).

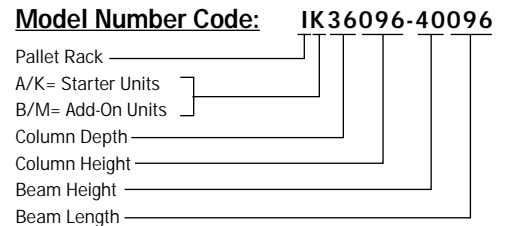

| Upright W x D | Beam Height | Cap. Per Pair | Starter Units | | Add-On Units | | Starter Units | | Add-On Units | |
|------------------|----------------|------------------|--------------------------------|---------------|-----------------|---------------|--------------------------------|---------------|-----------------|---------------|
| | | | Model Number | Price Each | Model Number | Price Each | Model Number | Price Each | Model Number | Price Each |
| | | | Regular Duty - 10' High | | | | Regular Duty - 12' High | | | |
| 36" x 96" | 4" | 4,148 | IA36120-40096 | 419.44 | IB36120-40096 | 314.08 | IA36144-40096 | 469.00 | IB36144-40096 | 338.86 |
| 36" x 96" | 5" | 5,863 | IA36120-50096 | 449.76 | IB36120-50096 | 344.40 | IA36144-50096 | 499.32 | IB36144-50096 | 369.18 |
| 36" x 108" | 4" | 3,523 | IA36120-40108 | 443.00 | IB36120-40108 | 337.64 | IA36144-40108 | 492.56 | IB36144-40108 | 362.42 |
| 36" x 108" | 5" | 5,919 | IA36120-50108 | 477.16 | IB36120-50108 | 371.80 | IA36144-50108 | 526.72 | IB36144-50108 | 396.58 |
| 36" x 120" | 4" | 2,854 | IA36120-40120 | 466.72 | IB36120-40120 | 361.36 | IA36144-40120 | 516.28 | IB36144-40120 | 386.14 |
| 36" x 120" | 5" | 5,003 | IA36120-50120 | 504.48 | IB36120-50120 | 399.12 | IA36144-50120 | 554.04 | IB36144-50120 | 423.90 |
| 36" x 144" | 5" | 3,475 | IA36120-50144 | 559.12 | IB36120-50144 | 453.76 | IA36144-50144 | 608.68 | IB36144-50144 | 478.54 |
| 36" x 144" | 6" | 6,000 | IA36120-60144 | 651.12 | IB36120-60144 | 545.76 | IA36144-60144 | 700.68 | IB36144-60144 | 570.54 |
| 42" x 96" | 4" | 4,148 | IA42120-40096 | 428.82 | IB42120-40096 | 318.77 | IA42144-40096 | 482.14 | IB42144-40096 | 345.43 |
| 42" x 96" | 5" | 5,863 | IA42120-50096 | 459.14 | IB42120-50096 | 349.09 | IA42144-50096 | 512.46 | IB42144-50096 | 375.75 |
| 42" x 108" | 4" | 3,523 | IA42120-40108 | 452.38 | IB42120-40108 | 342.33 | IA42144-40108 | 505.70 | IB42144-40108 | 368.99 |
| 42" x 108" | 5" | 5,919 | IA42120-50108 | 486.54 | IB42120-50108 | 376.49 | IA42144-50108 | 539.86 | IB42144-50108 | 403.15 |
| 42" x 120" | 4" | 2,854 | IA42120-40120 | 476.10 | IB42120-40120 | 366.05 | IA42144-40120 | 529.42 | IB42144-40120 | 392.71 |
| 42" x 120" | 5" | 5,003 | IA42120-50120 | 513.86 | IB42120-50120 | 403.81 | IA42144-50120 | 567.18 | IB42144-50120 | 430.47 |
| 42" x 144" | 5" | 3,475 | IA42120-50144 | 568.50 | IB42120-50144 | 458.45 | IA42144-50144 | 621.82 | IB42144-50144 | 485.11 |
| 42" x 144" | 6" | 6,000 | IA42120-60144 | 660.50 | IB42120-60144 | 550.45 | IA42144-60144 | 713.82 | IB42144-60144 | 577.11 |
| 48" x 96" | 4" | 4,148 | IA48120-40096 | 438.28 | IB48120-40096 | 323.50 | IA48144-40096 | 495.50 | IB48144-40096 | 352.11 |
| 48" x 96" | 5" | 5,863 | IA48120-50096 | 468.60 | IB48120-50096 | 353.82 | IA48144-50096 | 525.82 | IB48144-50096 | 382.43 |
| 48" x 108" | 4" | 3,523 | IA48120-40108 | 461.84 | IB48120-40108 | 347.06 | IA48144-40108 | 519.06 | IB48144-40108 | 375.67 |
| 48" x 108" | 5" | 5,919 | IA48120-50108 | 496.00 | IB48120-50108 | 381.22 | IA48144-50108 | 553.22 | IB48144-50108 | 409.83 |
| 48" x 120" | 4" | 2,854 | IA48120-40120 | 485.56 | IB48120-40120 | 370.78 | IA48144-40120 | 542.78 | IB48144-40120 | 399.39 |
| 48" x 120" | 5" | 5,003 | IA48120-50120 | 523.32 | IB48120-50120 | 408.54 | IA48144-50120 | 580.54 | IB48144-50120 | 437.15 |
| 48" x 144" | 5" | 3,475 | IA48120-50144 | 577.96 | IB48120-50144 | 463.18 | IA48144-50144 | 635.18 | IB48144-50144 | 491.79 |
| 48" x 144" | 6" | 6,000 | IA48120-60144 | 669.96 | IB48120-60144 | 555.18 | IA48144-60144 | 727.18 | IB48144-60144 | 583.79 |

Heavy Duty Upright Units

| Upright W x D | Beam Height | Cap. Per Pair | Starter Units | | Add-On Units | |
|------------------------------|----------------|------------------|-----------------|---------------|-----------------|---------------|
| | | | Model Number | Price Each | Model Number | Price Each |
| Heavy Duty - 10' High | | | | | | |
| 36" x 96" | 4" | 4,148 | IK36120-40096 | 534.00 | IM36120-40096 | 371.36 |
| 36" x 96" | 5" | 5,863 | IK36120-50096 | 564.32 | IM36120-50096 | 401.68 |
| 36" x 108" | 4" | 3,523 | IK36120-40108 | 557.56 | IM36120-40108 | 394.92 |
| 36" x 108" | 5" | 5,919 | IK36120-50108 | 591.72 | IM36120-50108 | 429.08 |
| 36" x 120" | 4" | 2,854 | IK36120-40120 | 581.28 | IM36120-40120 | 418.64 |
| 36" x 120" | 5" | 5,003 | IK36120-50120 | 619.04 | IM36120-50120 | 456.40 |
| 36" x 144" | 5" | 3,475 | IK36120-50144 | 673.68 | IM36120-50144 | 511.04 |
| 36" x 144" | 6" | 6,000 | IK36120-60144 | 765.68 | IM36120-60144 | 603.04 |
| 42" x 96" | 4" | 4,148 | IK42120-40096 | 539.94 | IM42120-40096 | 374.33 |
| 42" x 96" | 5" | 5,863 | IK42120-50096 | 570.26 | IM42120-50096 | 404.65 |
| 42" x 108" | 4" | 3,523 | IK42120-40108 | 563.50 | IM42120-40108 | 397.89 |
| 42" x 108" | 5" | 5,919 | IK42120-50108 | 597.66 | IM42120-50108 | 432.05 |
| 42" x 120" | 4" | 2,854 | IK42120-40120 | 587.22 | IM42120-40120 | 421.61 |
| 42" x 120" | 5" | 5,003 | IK42120-50120 | 624.98 | IM42120-50120 | 459.37 |
| 42" x 144" | 5" | 3,475 | IK42120-50144 | 679.62 | IM42120-50144 | 514.01 |
| 42" x 144" | 6" | 6,000 | IK42120-60144 | 771.62 | IM42120-60144 | 606.01 |
| 48" x 96" | 4" | 4,148 | IK48120-40096 | 546.80 | IM48120-40096 | 377.76 |
| 48" x 96" | 5" | 5,863 | IK48120-50096 | 577.12 | IM48120-50096 | 408.08 |
| 48" x 108" | 4" | 3,523 | IK48120-40108 | 570.36 | IM48120-40108 | 401.32 |
| 48" x 108" | 5" | 5,919 | IK48120-50108 | 604.52 | IM48120-50108 | 435.48 |
| 48" x 120" | 4" | 2,854 | IK48120-40120 | 594.08 | IM48120-40120 | 425.04 |
| 48" x 120" | 5" | 5,003 | IK48120-50120 | 631.84 | IM48120-50120 | 462.80 |
| 48" x 144" | 5" | 3,475 | IK48120-50144 | 686.48 | IM48120-50144 | 517.44 |
| 48" x 144" | 6" | 6,000 | IK48120-60144 | 778.48 | IM48120-60144 | 609.44 |

| Upright W x D | Beam Height | Cap. Per Pair | Starter Units | | Add-On Units | | Starter Units | | Add-On Units | |
|------------------|----------------|------------------|------------------------------|---------------|-----------------|---------------|------------------------------|---------------|-----------------|---------------|
| | | | Model Number | Price Each | Model Number | Price Each | Model Number | Price Each | Model Number | Price Each |
| | | | Heavy Duty - 12' High | | | | Heavy Duty - 16' High | | | |
| 36" x 96" | 4" | 4,148 | IK36144-40096 | 587.74 | IM36144-40096 | 398.23 | IK36192-40096 | 695.82 | IM36192-40096 | 452.27 |
| 36" x 96" | 5" | 5,863 | IK36144-50096 | 618.06 | IM36144-50096 | 428.55 | IK36192-50096 | 726.14 | IM36192-50096 | 482.59 |
| 36" x 108" | 4" | 3,523 | IK36144-40108 | 611.30 | IM36144-40108 | 421.79 | IK36192-40108 | 719.38 | IM36192-40108 | 475.83 |
| 36" x 108" | 5" | 5,919 | IK36144-50108 | 645.46 | IM36144-50108 | 455.95 | IK36192-50108 | 753.54 | IM36192-50108 | 509.99 |
| 36" x 120" | 4" | 2,854 | IK36144-40120 | 635.02 | IM36144-40120 | 445.51 | IK36192-40120 | 743.10 | IM36192-40120 | 499.55 |
| 36" x 120" | 5" | 5,003 | IK36144-50120 | 672.78 | IM36144-50120 | 483.27 | IK36192-50120 | 780.86 | IM36192-50120 | 537.31 |
| 36" x 144" | 5" | 3,475 | IK36144-50144 | 727.42 | IM36144-50144 | 537.91 | IK36192-50144 | 835.50 | IM36192-50144 | 591.95 |
| 36" x 144" | 6" | 6,000 | IK36144-60144 | 819.42 | IM36144-60144 | 629.91 | IK36192-60144 | 927.50 | IM36192-60144 | 683.95 |
| 42" x 96" | 4" | 4,148 | IK42144-40096 | 594.44 | IM42144-40096 | 401.58 | IK42192-40096 | 698.72 | IM42192-40096 | 453.72 |
| 42" x 96" | 5" | 5,863 | IK42144-50096 | 624.76 | IM42144-50096 | 431.90 | IK42192-50096 | 729.04 | IM42192-50096 | 484.04 |
| 42" x 108" | 4" | 3,523 | IK42144-40108 | 618.00 | IM42144-40108 | 425.14 | IK42192-40108 | 722.28 | IM42192-40108 | 477.28 |
| 42" x 108" | 5" | 5,919 | IK42144-50108 | 652.16 | IM42144-50108 | 459.30 | IK42192-50108 | 756.44 | IM42192-50108 | 511.44 |
| 42" x 120" | 4" | 2,854 | IK42144-40120 | 641.72 | IM42144-40120 | 448.86 | IK42192-40120 | 746.00 | IM42192-40120 | 501.00 |
| 42" x 120" | 5" | 5,003 | IK42144-50120 | 679.48 | IM42144-50120 | 486.62 | IK42192-50120 | 783.76 | IM42192-50120 | 538.76 |
| 42" x 144" | 5" | 3,475 | IK42144-50144 | 734.12 | IM42144-50144 | 541.26 | IK42192-50144 | 838.40 | IM42192-50144 | 593.40 |
| 42" x 144" | 6" | 6,000 | IK42144-60144 | 826.12 | IM42144-60144 | 633.26 | IK42192-60144 | 930.40 | IM42192-60144 | 685.40 |
| 48" x 96" | 4" | 4,148 | IK48144-40096 | 602.00 | IM48144-40096 | 405.36 | IK48192-40096 | 715.94 | IM48192-40096 | 462.33 |
| 48" x 96" | 5" | 5,863 | IK48144-50096 | 632.32 | IM48144-50096 | 435.68 | IK48192-50096 | 746.26 | IM48192-50096 | 492.65 |
| 48" x 108" | 4" | 3,523 | IK48144-40108 | 625.56 | IM48144-40108 | 428.92 | IK48192-40108 | 739.50 | IM48192-40108 | 485.89 |
| 48" x 108" | 5" | 5,919 | IK48144-50108 | 659.72 | IM48144-50108 | 463.08 | IK48192-50108 | 773.66 | IM48192-50108 | 520.05 |
| 48" x 120" | 4" | 2,854 | IK48144-40120 | 649.28 | IM48144-40120 | 452.64 | IK48192-40120 | 763.22 | IM48192-40120 | 509.61 |
| 48" x 120" | 5" | 5,003 | IK48144-50120 | 687.04 | IM48144-50120 | 490.40 | IK48192-50120 | 800.98 | IM48192-50120 | 547.37 |
| 48" x 144" | 5" | 3,475 | IK48144-50144 | 741.68 | IM48144-50144 | 545.04 | IK48192-50144 | 855.62 | IM48192-50144 | 602.01 |
| 48" x 144" | 6" | 6,000 | IK48144-60144 | 833.68 | IM48144-60144 | 637.04 | IK48192-60144 | 947.62 | IM48192-60144 | 694.01 |

How to Order

Uprights

1. Upright Capacity

Calculate upright capacity by adding total weight of goods being stored. Do not include goods being placed on floor.

2. Upright Height

Step #1 - Calculate load height by adding height of palletized goods plus 6" for clearance between palletized goods and the beam supporting the next level.

Step #2 - Add height of beam (either 3.5", 4", 5" or 6")

Step #3 - Multiply the sum of Step #1 and Step #2 by the number of load levels.

Note: Top load height need not be counted in determining upright height.

3. Upright Depth

Deduct 6" from pallet depth to allow 3" pallet overhang front and rear. For example: a 48" deep pallet would require a 42" deep upright.

Load Beams

1. Beam Length

Multiply pallet width by the number of pallets being stored on each level plus 12" for clearance. For example: two 48" wide pallets would require 108" long beams.

2. Beam Capacity

Determine capacity by multiplying the number of pallets per pair of load beams by the weight of each pallet.

Wall Cantilever Rack

This Cantilever Rack is the ideal wall mounted solution that stores bar stock, lumber and more. Each cantilever section features 7 arms for highly flexible storage. Unit can store up to 100 lbs. per arm or a total capacity of 700 lbs. Mount a series of sections along a wall to accommodate storage for extremely long stock. Each cantilever section measures 60"H; three arms measure 15" with a 7.25" clearance; four 12" arms that feature 9" clearances. Features an attractive zinc plated finish. Assembles in minutes. Sold in single sections. Minimum 2 sections needed.



3 Sections Shown

| Height | Model Number | Price Each |
|--------|--------------|------------|
| 60" | 215-WMC01 | \$82.50 |

Medium Duty Cantilever Rack

Ideal for storing long products such as bars, pipes and rods. Available as either a single or double sided units. Two bases/columns, four brace beams and arms are required to make one free standing unit. All units are 79" tall. Arms are adjustable in 1/2" increments. Choose either 12", 18" or 24" arms. Angled arms and welded end-stops provide secure/safe storage of long and/or irregular shaped merchandise. Connect multiple units to provide storage of extra long stock. Units assemble in less than 10 minutes.



Arms

| Length | Model Number | Price Each |
|--------|--------------|------------|
| 12" | 215-GA12 | 15.50 |
| 18" | 215-GA18 | 20.16 |
| 24" | 215-GA24 | 27.29 |



Brace Beams

| Length | Model Number | Price Each |
|--------|--------------|------------|
| 36" | 215-CBL30036 | 11.80 |
| 48" | 215-CB30048 | 17.44 |
| 72" | 215-CB30072 | 25.28 |



Single Sided Bases/Columns

| Arm Length | Model Number | Price Each |
|------------|--------------|------------|
| 12" | 215-GCS08012 | 163.65 |
| 18" | 215-GCS08018 | 180.00 |
| 24" | 205-GCS08024 | 215.98 |



Double Sided Bases/Columns

| Arm Length | Model Number | Price Each |
|------------|--------------|------------|
| 12" | 215-GCD08012 | 184.96 |
| 18" | 215-GCD08018 | 203.46 |
| 24" | 205-GCD08024 | 244.15 |



Single Sided Unit



Double Sided Unit

Heavy Duty Cantilever Rack

This cantilever rack is the ideal heavy duty storage for tubes, bar stock or other long materials. Available with either a single sided or double sided base. Columns are available in 8', 10' or 12' heights. Arms are available in 24", 36" or 48" lengths. Two bases/columns, one brace set and arms are required to make one free standing starter unit. Additional sections can be added to a starter unit by purchasing one additional base/column, one brace set and arms. All components are sold individually and are listed below

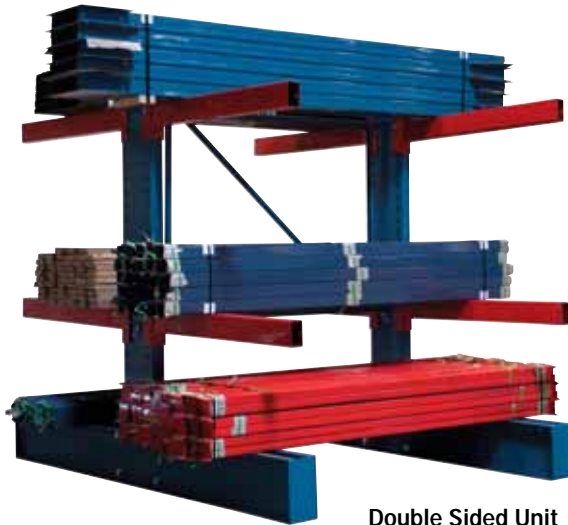

Double Sided Unit



Arm End-Stops

Provides secure and safe storage of long and/or irregular shaped merchandise. End-Stops Sold separately.

| *Fits Arm | Model Number | Price Each |
|-----------|--------------|------------|
| 4° | CHAHS01 | 8.72 |
| 20° | CHAHS02 | 8.72 |

**For use with Heavy Duty Arms only*

How to Order

- Select Arms**
 - Choose Arm Length
 - Choose either Regular Duty or Heavy Duty based on required capacity
- Select Base/Column Size**
 - Choose either single sided or double sided base.
 - Choose column height:
When columns serve as load stops, it is necessary to specify column heights greater than the top loading arms.
There is no need to pay for extra column height unless load stops are desired or future expansion is anticipated
 - Select appropriate base for arms selected in Step 1 above.
- Select Brace Set**
 - A brace set must be installed between each pair of columns.

Step 1 - Arms

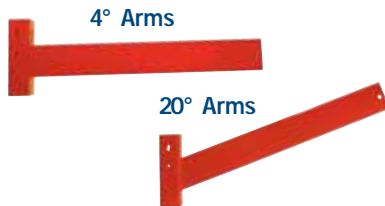

| 20° Arms | | | |
|------------|--------------|--------------|------------|
| Arm Length | Cap. Per Arm | Model Number | Price Each |
| Heavy Duty | | | |
| 24" | 2,200 | 215-HBH24 | 50.25 |
| 36" | 2,050 | 215-HBH36 | 67.08 |
| 48" | 1,600 | 215-HBH48 | 80.76 |

| 4° Arms | | | |
|--------------|--------------|--------------|------------|
| Arm Length | Cap. Per Arm | Model Number | Price Each |
| Regular Duty | | | |
| 24" | 1,800 | 215-HA24 | 30.99 |
| 36" | 1,200 | 215-HA36 | 39.12 |
| 48" | 900 | 215-HA48 | 47.26 |
| Heavy Duty | | | |
| 36" | 2,050 | 215-HAH36 | 60.98 |
| 48" | 1,600 | 215-HAH48 | 73.42 |

Step 2 - Bases/Columns

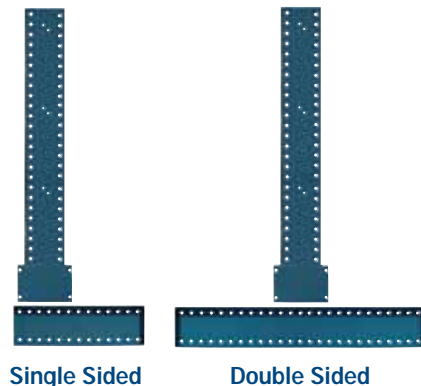

Single Sided

Double Sided

| Single Sided Bases/Columns | | | |
|----------------------------|--------------|--------------|------------|
| Arm Length | Cap. Per Arm | Model Number | Price Each |
| 8'H Column | | | |
| 24" | 11,200 | CHS-09624 | 419.19 |
| 36" | 8,400 | CHS-09636 | 449.94 |
| 48" | 6,700 | CHS-09648 | 480.67 |
| 10'H Column | | | |
| 24" | 11,200 | CHS-12024 | 480.42 |
| 36" | 8,400 | CHS-12036 | 511.15 |
| 48" | 6,700 | CHS-12048 | 541.90 |
| 12'H Column | | | |
| 24" | 11,200 | CHS-14424 | 541.64 |
| 36" | 8,400 | CHS-14436 | 572.39 |
| 48" | 6,700 | CHS-14448 | 603.12 |

| Double Sided Bases/Columns | | | |
|----------------------------|--------------|--------------|------------|
| Arm Length | Cap. Per Arm | Model Number | Price Each |
| 8'H Column | | | |
| 24" | 22,400 | CHD-09624 | 510.91 |
| 36" | 16,800 | CHD-09636 | 572.89 |
| 48" | 13,400 | CHD-09648 | 621.39 |
| 10'H Column | | | |
| 24" | 22,400 | CHD-12024 | 572.13 |
| 36" | 16,800 | CHD-12036 | 634.11 |
| 48" | 13,400 | CHD-12048 | 682.62 |
| 12'H Column | | | |
| 24" | 22,400 | CHD-14424 | 633.35 |
| 36" | 16,800 | CHD-14436 | 695.34 |
| 48" | 13,400 | CHD-14448 | 743.83 |

Step 3 - Brace Sets

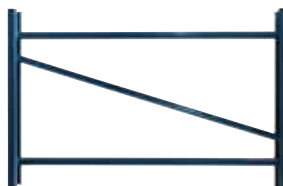

| Width | 8' & 10' High | | 12' High | |
|-------|---------------|------------|--------------|------------|
| | Model Number | Price Each | Model Number | Price Each |
| 3' | 215-HXP36 | 46.41 | 215-CHX36 | 56.75 |
| 4' | 215-HXP48 | 55.78 | 215-CHX48 | 70.00 |
| 6' | 215-HXP72 | 75.31 | 215-CHX72 | 97.30 |
| 8' | 215-HXP96 | 95.40 | 215-CHX96 | 125.14 |

Boltless Workbenches with Particle Board Decking

These rugged benches utilize the Series 200B boltless design which provides high capacity and quick assembly. Ideal for assembly areas and shipping/receiving areas. Available in a variety of configurations and sizes to fit your specific needs. Workbenches feature 1/2" particle board worksurfaces. Worksurfaces are 36" high. Elevated shelves are 24" above worksurface and are 12" deep. Steel color: Gray.

Standard Workbench



| W x D | Surface Cap. | Model Number | Price Each |
|-----------|--------------|-------------------|------------|
| 48" x 24" | 1,000 | BW1-4824-W | 59.10 |
| 48" x 30" | 1,000 | BW1-4830-W | 64.51 |
| 48" x 36" | 1,000 | BW1-4836-W | 75.46 |
| 48" x 48" | 1,000 | BW1-4848-W | 87.73 |
| 60" x 24" | 750 | BW1-6024-W | 68.35 |
| 60" x 30" | 750 | BW1-6030-W | 74.48 |
| 60" x 36" | 1,250 | BW1-6036-W | 86.06 |
| 60" x 48" | 1,250 | BW1-6048-W | 99.57 |
| 72" x 24" | 600 | BW1-7224-W | 75.42 |
| 72" x 30" | 1,000 | BW1-7230-W | 87.04 |
| 72" x 36" | 1,000 | BW1-7236-W | 94.36 |
| 72" x 48" | 1,000 | BW1-7248-W | 109.13 |
| 96" x 24" | 600 | BW1-9624-W | 94.36 |
| 96" x 30" | 600 | BW1-9630-W | 102.84 |
| 96" x 36" | 600 | BW1-9636-W | 111.41 |
| 96" x 48" | 600 | BW1-9648-W | 128.67 |

Workbench plus Bottom Shelf



| W x D | Surface Cap. | Model Number | Price Each |
|-----------|--------------|-------------------|------------|
| 48" x 24" | 1,000 | BW2-4824-W | 75.18 |
| 48" x 30" | 1,000 | BW2-4830-W | 83.16 |
| 48" x 36" | 1,000 | BW2-4836-W | 102.13 |
| 48" x 48" | 1,000 | BW2-4848-W | 120.98 |
| 60" x 24" | 750 | BW2-6024-W | 89.30 |
| 60" x 30" | 750 | BW2-6030-W | 98.54 |
| 60" x 36" | 1,250 | BW2-6036-W | 118.75 |
| 60" x 48" | 1,250 | BW2-6048-W | 140.10 |
| 72" x 24" | 600 | BW2-7224-W | 100.39 |
| 72" x 30" | 1,000 | BW2-7230-W | 120.63 |
| 72" x 36" | 1,000 | BW2-7236-W | 132.33 |
| 72" x 48" | 1,000 | BW2-7248-W | 156.17 |
| 96" x 24" | 600 | BW2-9624-W | 134.05 |
| 96" x 30" | 600 | BW2-9630-W | 145.83 |
| 96" x 36" | 600 | BW2-9636-W | 160.04 |
| 96" x 48" | 600 | BW2-9648-W | 188.86 |

Workbench plus Top Shelf



| W x D | Surface Cap. | Model Number | Price Each |
|-----------|--------------|-------------------|------------|
| 48" x 24" | 1,000 | BW3-4824-W | 89.55 |
| 48" x 30" | 1,000 | BW3-4830-W | 94.82 |
| 48" x 36" | 1,000 | BW3-4836-W | 106.00 |
| 48" x 48" | 1,000 | BW3-4848-W | 118.27 |
| 60" x 24" | 750 | BW3-6024-W | 111.26 |
| 60" x 30" | 750 | BW3-6030-W | 118.87 |
| 60" x 36" | 1,250 | BW3-6036-W | 122.42 |
| 60" x 48" | 1,250 | BW3-6048-W | 135.92 |
| 72" x 24" | 600 | BW3-7224-W | 118.67 |
| 72" x 30" | 1,000 | BW3-7230-W | 127.68 |
| 72" x 36" | 1,000 | BW3-7236-W | 135.01 |
| 72" x 48" | 1,000 | BW3-7248-W | 158.19 |
| 96" x 24" | 600 | BW3-9624-W | 143.87 |
| 96" x 30" | 600 | BW3-9630-W | 156.42 |
| 96" x 36" | 600 | BW3-9636-W | 160.92 |
| 96" x 48" | 600 | BW3-9648-W | 178.17 |

Workbench plus Top & Bottom Shelf



| W x D | Surface Cap. | Model Number | Price Each |
|-----------|--------------|-------------------|------------|
| 48" x 24" | 1,000 | BW4-4824-W | 105.72 |
| 48" x 30" | 1,000 | BW4-4830-W | 113.70 |
| 48" x 36" | 1,000 | BW4-4836-W | 132.67 |
| 48" x 48" | 1,000 | BW4-4848-W | 151.51 |
| 60" x 24" | 750 | BW4-6024-W | 125.66 |
| 60" x 30" | 750 | BW4-6030-W | 134.89 |
| 60" x 36" | 1,250 | BW4-6036-W | 155.11 |
| 60" x 48" | 1,250 | BW4-6048-W | 176.45 |
| 72" x 24" | 600 | BW4-7224-W | 141.03 |
| 72" x 30" | 1,000 | BW4-7230-W | 161.28 |
| 72" x 36" | 1,000 | BW4-7236-W | 172.98 |
| 72" x 48" | 1,000 | BW4-7248-W | 196.82 |
| 96" x 24" | 600 | BW4-9624-W | 181.42 |
| 96" x 30" | 600 | BW4-9630-W | 195.34 |
| 96" x 36" | 600 | BW4-9636-W | 209.54 |
| 96" x 48" | 600 | BW4-9648-W | 238.36 |

Height Adjustable Industrial Workbenches

Durable steel height adjustable workbenches at a great value. Worksurface height from the floor can be adjusted from 31"–37". Available in a variety of configurations to fit your specific needs and budget. Choose from Shop Top or Steel topsurfaces. All welded steel legs are designed to support the most demanding applications. Elevated shelves are 12" above the worksurface and are 10" deep. Easy to assemble. Steel color: Gray.



Adjustable Leg Stand



Standard Workbench



Workbench plus Bottom Shelf

| W x D | Shop Top | | Steel Top | |
|-----------|--------------|------------|--------------|------------|
| | Model Number | Price Each | Model Number | Price Each |
| 60" x 30" | G55T-6030 | 269.64 | G55S-6030 | 287.03 |
| 60" x 36" | G55T-6036 | 277.18 | G55S-6036 | 310.64 |
| 72" x 30" | G55T-7230 | 282.27 | G55S-7230 | 317.15 |
| 72" x 36" | G55T-7236 | 293.90 | G55S-7236 | 336.59 |

| W x D | Shop Top | | Steel Top | |
|-----------|--------------|------------|--------------|------------|
| | Model Number | Price Each | Model Number | Price Each |
| 60" x 30" | G56T-6030 | 310.23 | G56S-6030 | 327.60 |
| 60" x 36" | G56T-6036 | 317.77 | G56S-6036 | 351.23 |
| 72" x 30" | G56T-7230 | 332.25 | G56S-7230 | 367.13 |
| 72" x 36" | G56T-7236 | 343.88 | G56S-7236 | 386.52 |



Workbench plus Bottom Shelf & Riser



Workbench plus Bottom Shelf, Riser & Drawer

| W x D | Shop Top | | Steel Top | |
|-----------|--------------|------------|--------------|------------|
| | Model Number | Price Each | Model Number | Price Each |
| 60" x 30" | G58T-6030 | 370.15 | G58S-6030 | 387.52 |
| 60" x 36" | G58T-6036 | 377.69 | G58S-6036 | 411.15 |
| 72" x 30" | G58T-7230 | 399.25 | G58S-7230 | 434.13 |
| 72" x 36" | G58T-7236 | 410.88 | G58S-7236 | 453.57 |

| W x D | Shop Top | | Steel Top | |
|-----------|--------------|------------|--------------|------------|
| | Model Number | Price Each | Model Number | Price Each |
| 60" x 30" | G59T-6030 | 625.03 | G59S-6030 | 641.48 |
| 60" x 36" | G59T-6036 | 635.87 | G59S-6036 | 669.32 |
| 72" x 30" | G59T-7230 | 654.13 | G59S-7230 | 688.07 |
| 72" x 36" | G59T-7236 | 669.06 | G59S-7236 | 711.75 |

FastRak Heavy Duty Workbenches

The FastRak workbench utilizes the same heavy-duty components as our popular FastRak bulk storage shelving. Great for heavy-duty applications including workshops, shipping/receiving areas and assembly lines. These workbenches are extremely rugged and can support up to 1,800 lbs. on a 72" wide unit. Thick 3/4" particle board fits inside step beams to create a flush worksurface that is approximately 36" high. Workbench utilizes steel supports for an exceptionally strong worksurface. Easy to assemble: Heavy-duty step load beams lock into one-piece and upright legs can be assembled in minutes. Anchor uprights to the floor with optional Deluxe Footplates (see page 7 for footplate pricing).



| W x D | Shelf Cap. | Workbench | | Workbench w/Bottom Shelf | |
|-----------|------------|--------------|------------|--------------------------|------------|
| | | Model Number | Price Each | Model Number | Price Each |
| 48" x 36" | 2,000 | KB1-4836-W | 171.63 | KB2-4836-W | 219.24 |
| 48" x 48" | 2,000 | KB1-4848-W | 198.91 | KB2-4848-W | 256.46 |
| 72" x 36" | 1,800 | KB1-7236-W | 210.27 | KB2-7236-W | 280.81 |
| 72" x 48" | 1,800 | KB1-7248-W | 242.50 | KB2-7248-W | 327.97 |
| 96" x 36" | 1,600 | KB1-9636-W | 248.90 | KB2-9636-W | 342.39 |
| 96" x 48" | 1,600 | KB1-9648-W | 286.12 | KB2-9648-W | 399.47 |

Series 200B Stationary Bin Storage Units

Jumbo bin storage units come complete with bins. Bins are made of heavy duty polypropylene and are unaffected by water, grease and oil. Shelving features a heavy duty industrial boltless design which provides for quick, easy assembly and years of dependable service. These units are a cost effective way to store small, medium and large parts. Shelving comes complete with bins and particle board decking.



Enhance bin functionality by purchasing bin dividers and windows (see page 28)

| Bin D x W x H | Unit W x D x H | Bins Per Level | # of Levels w/Bins | Total # of Bins | # of Shelves | Model Number | Price Each |
|--|-----------------|----------------|--------------------|-----------------|--------------|-----------------|------------|
| 12"D Bins | | | | | | | |
| 10 $\frac{1}{8}$ " x 5 $\frac{1}{2}$ " x 5" | 36" x 12" x 72" | 6 | 7 | 42 | 8 | QR1-(B/Y/R)230* | 393.06 |
| 10 $\frac{1}{8}$ " x 5 $\frac{1}{2}$ " x 5" | 48" x 12" x 72" | 8 | 7 | 56 | 8 | QR2-(B/Y/R)230* | 499.28 |
| 10 $\frac{1}{8}$ " x 5 $\frac{1}{2}$ " x 5" | 60" x 12" x 72" | 10 | 7 | 70 | 8 | QR3-(B/Y/R)230* | 619.02 |
| 10 $\frac{1}{8}$ " x 5 $\frac{1}{2}$ " x 5" | 72" x 12" x 72" | 12 | 7 | 84 | 8 | QR4-(B/Y/R)230* | 712.04 |
| 10 $\frac{1}{8}$ " x 5 $\frac{1}{2}$ " x 5" | 96" x 12" x 72" | 16 | 7 | 112 | 8 | QR5-(B/Y/R)230* | 944.96 |
| 10 $\frac{1}{8}$ " x 11" x 5" | 36" x 12" x 72" | 3 | 7 | 21 | 8 | QR1-(B/Y/R)235* | 338.46 |
| 10 $\frac{1}{8}$ " x 11" x 5" | 48" x 12" x 72" | 4 | 7 | 28 | 8 | QR2-(B/Y/R)235* | 426.48 |
| 10 $\frac{1}{8}$ " x 11" x 5" | 60" x 12" x 72" | 5 | 7 | 35 | 8 | QR3-(B/Y/R)235* | 528.02 |
| 10 $\frac{1}{8}$ " x 11" x 5" | 72" x 12" x 72" | 6 | 7 | 42 | 8 | QR4-(B/Y/R)235* | 602.84 |
| 10 $\frac{1}{8}$ " x 11" x 5" | 96" x 12" x 72" | 8 | 7 | 56 | 8 | QR5-(B/Y/R)235* | 799.36 |
| 10 $\frac{3}{4}$ " x 8 $\frac{1}{4}$ " x 7" | 36" x 12" x 72" | 4 | 6 | 24 | 7 | QR1-(B/Y/R)239* | 357.91 |
| 10 $\frac{3}{4}$ " x 8 $\frac{1}{4}$ " x 7" | 48" x 12" x 72" | 5 | 6 | 30 | 7 | QR2-(B/Y/R)239* | 437.18 |
| 10 $\frac{3}{4}$ " x 8 $\frac{1}{4}$ " x 7" | 60" x 12" x 72" | 7 | 6 | 42 | 7 | QR3-(B/Y/R)239* | 638.00 |
| 10 $\frac{3}{4}$ " x 8 $\frac{1}{4}$ " x 7" | 72" x 12" x 72" | 8 | 6 | 48 | 7 | QR4-(B/Y/R)239* | 646.64 |
| 10 $\frac{3}{4}$ " x 8 $\frac{1}{4}$ " x 7" | 96" x 12" x 72" | 11 | 6 | 66 | 7 | QR5-(B/Y/R)239* | 873.74 |
| 15"D Bins | | | | | | | |
| 14 $\frac{3}{4}$ " x 8 $\frac{1}{2}$ " x 7" | 36" x 15" x 72" | 4 | 6 | 24 | 7 | QR1-(B/Y/R)240* | 423.85 |
| 14 $\frac{3}{4}$ " x 8 $\frac{1}{2}$ " x 7" | 48" x 15" x 72" | 5 | 6 | 30 | 7 | QR2-(B/Y/R)240* | 519.15 |
| 14 $\frac{3}{4}$ " x 8 $\frac{1}{2}$ " x 7" | 60" x 15" x 72" | 7 | 6 | 42 | 7 | QR3-(B/Y/R)240* | 766.17 |
| 14 $\frac{3}{4}$ " x 8 $\frac{1}{2}$ " x 7" | 72" x 15" x 72" | 8 | 6 | 48 | 7 | QR4-(B/Y/R)240* | 787.76 |
| 14 $\frac{3}{4}$ " x 8 $\frac{1}{2}$ " x 7" | 96" x 15" x 72" | 11 | 6 | 66 | 7 | QR5-(B/Y/R)240* | 1,047.76 |
| 14 $\frac{3}{4}$ " x 16 $\frac{1}{2}$ " x 7" | 36" x 15" x 72" | 2 | 6 | 12 | 7 | QR1-(B/Y/R)250* | 356.65 |
| 14 $\frac{3}{4}$ " x 16 $\frac{1}{2}$ " x 7" | 60" x 15" x 72" | 3 | 6 | 18 | 7 | QR3-(B/Y/R)250* | 525.62 |
| 14 $\frac{3}{4}$ " x 16 $\frac{1}{2}$ " x 7" | 72" x 15" x 72" | 4 | 6 | 24 | 7 | QR4-(B/Y/R)250* | 653.36 |
| 14 $\frac{3}{4}$ " x 16 $\frac{1}{2}$ " x 7" | 96" x 15" x 72" | 5 | 6 | 30 | 7 | QR5-(B/Y/R)250* | 815.26 |
| 18"D Bins | | | | | | | |
| 18" x 11" x 10" | 36" x 18" x 72" | 3 | 5 | 15 | 6 | QR1-(B/Y/R)260* | 455.66 |
| 18" x 11" x 10" | 48" x 18" x 72" | 4 | 5 | 20 | 6 | QR2-(B/Y/R)260* | 583.42 |
| 18" x 11" x 10" | 60" x 18" x 72" | 5 | 5 | 25 | 6 | QR3-(B/Y/R)260* | 721.20 |
| 18" x 11" x 10" | 72" x 18" x 72" | 6 | 5 | 30 | 6 | QR4-(B/Y/R)260* | 850.52 |
| 18" x 11" x 10" | 96" x 18" x 72" | 8 | 5 | 40 | 6 | QR5-(B/Y/R)260* | 1,110.24 |
| 18" x 16 $\frac{1}{2}$ " x 11" | 36" x 18" x 72" | 2 | 4 | 8 | 5 | QR1-(B/Y/R)270* | 349.74 |
| 18" x 16 $\frac{1}{2}$ " x 11" | 60" x 18" x 72" | 3 | 4 | 12 | 5 | QR3-(B/Y/R)270* | 511.67 |
| 18" x 16 $\frac{1}{2}$ " x 11" | 72" x 18" x 72" | 4 | 4 | 16 | 5 | QR4-(B/Y/R)270* | 643.00 |
| 18" x 16 $\frac{1}{2}$ " x 11" | 96" x 18" x 72" | 5 | 4 | 20 | 5 | QR5-(B/Y/R)270* | 800.08 |

Series 200B Mobile Bin Storage Units

Mobile bin storage units come complete with bins. These highly functional mobile shelf carts are built to last. Heavy duty steel construction ensures years of dependable service. Bins are made of heavy duty polypropylene and are unaffected by water, grease and oil. These mobile units include four heavy duty 5" casters (two swivel and two rigid). Unit height 78". Steel color: Gray. Cart capacity: 600 lbs.



Advanced boltless shelf design that utilizes the strength of double rivet beams



| Bin D x W x H | Unit W x D x H | Bins Per Level | # of Levels w/Bins | Total # of Bins | # of Shelves | Model Number | Price Each |
|---|-----------------|----------------|--------------------|-----------------|--------------|------------------|------------|
| Single Sided - 12"D Mobile Bin Units | | | | | | | |
| 10 $\frac{1}{8}$ " x 5 $\frac{1}{2}$ " x 5" | 36" x 12" x 78" | 6 | 7 | 42 | 8 | QL1-(B/Y/R)230* | 492.87 |
| 10 $\frac{1}{8}$ " x 5 $\frac{1}{2}$ " x 5" | 48" x 12" x 78" | 8 | 7 | 56 | 8 | QL2-(B/Y/R)230* | 609.22 |
| 10 $\frac{1}{8}$ " x 11" x 5" | 36" x 12" x 78" | 3 | 7 | 21 | 8 | QL1-(B/Y/R)235* | 438.27 |
| 10 $\frac{1}{8}$ " x 11" x 5" | 48" x 12" x 78" | 4 | 7 | 28 | 8 | QL2-(B/Y/R)235* | 536.42 |
| 10 $\frac{3}{4}$ " x 8 $\frac{1}{4}$ " x 7" | 36" x 12" x 78" | 4 | 6 | 24 | 7 | QL1-(B/Y/R)239* | 457.72 |
| 10 $\frac{3}{4}$ " x 8 $\frac{1}{4}$ " x 7" | 48" x 12" x 78" | 5 | 6 | 30 | 7 | QL2-(B/Y/R)239* | 547.12 |
| Double Sided - 24"D Mobile Bin Units | | | | | | | |
| 10 $\frac{1}{8}$ " x 5 $\frac{1}{2}$ " x 5" | 36" x 24" x 78" | 12 | 7 | 84 | 8 | QLD1-(B/Y/R)230* | 773.27 |
| 10 $\frac{1}{8}$ " x 5 $\frac{1}{2}$ " x 5" | 48" x 24" x 78" | 16 | 7 | 112 | 8 | QLD2-(B/Y/R)230* | 965.87 |
| 10 $\frac{1}{8}$ " x 11" x 5" | 36" x 24" x 78" | 6 | 7 | 42 | 8 | QLD1-(B/Y/R)235* | 664.07 |
| 10 $\frac{1}{8}$ " x 11" x 5" | 48" x 24" x 78" | 8 | 7 | 56 | 8 | QLD2-(B/Y/R)235* | 820.27 |
| 10 $\frac{3}{4}$ " x 8 $\frac{1}{4}$ " x 7" | 36" x 24" x 78" | 8 | 6 | 48 | 7 | QLD1-(B/Y/R)239* | 713.86 |
| 10 $\frac{3}{4}$ " x 8 $\frac{1}{4}$ " x 7" | 48" x 24" x 78" | 10 | 6 | 60 | 7 | QLD2-(B/Y/R)239* | 855.41 |
| 10 $\frac{3}{4}$ " x 8 $\frac{1}{4}$ " x 7" | 60" x 24" x 78" | 14 | 6 | 84 | 7 | QLD3-(B/Y/R)239* | 1,117.71 |
| Single Sided - 18"D Mobile Bin Units | | | | | | | |
| 18" x 11" x 10" | 36" x 18" x 78" | 3 | 5 | 15 | 6 | QL1-(B/Y/R)260* | 566.96 |
| 18" x 11" x 10" | 48" x 18" x 78" | 4 | 5 | 20 | 6 | QL2-(B/Y/R)260* | 704.22 |
| 18" x 11" x 10" | 60" x 18" x 78" | 5 | 5 | 25 | 6 | QL3-(B/Y/R)260* | 851.51 |
| 18" x 16 $\frac{1}{2}$ " x 11" | 36" x 18" x 78" | 2 | 4 | 8 | 5 | QL1-(B/Y/R)270* | 519.18 |
| 18" x 16 $\frac{1}{2}$ " x 11" | 60" x 18" x 78" | 3 | 4 | 12 | 5 | QL3-(B/Y/R)270* | 673.45 |
| Single Sided - 36"D Mobile Bin Units | | | | | | | |
| 18" x 11" x 10" | 48" x 36" x 78" | 8 | 5 | 30 | 6 | QLD2-(B/Y/R)260* | 987.33 |
| 18" x 11" x 10" | 60" x 36" x 78" | 10 | 5 | 40 | 6 | QLD3-(B/Y/R)260* | 1,238.20 |
| 18" x 16 $\frac{1}{2}$ " x 11" | 60" x 36" x 78" | 6 | 4 | 24 | 5 | QLD3-(B/Y/R)270* | 1,035.95 |

Stackable Bins

Stackable bins are made of heavy duty polypropylene with permanent molded-in color. They are virtually unbreakable and are water, rust and corrosion-proof. Ideal for assembly, production, manufacturing or repair areas. Finger grips are provided for ease of handling. Bin fronts have a large slotted label area. Reinforced ribs prevent bins from spreading under loads. Clear plastic windows are available to increase bin storage capacity while maintaining easy visibility of bin contents. Enhance bin functionality by adding optional bin dividers. Choose from 9 different sizes and 3 different colors (Blue, Yellow & Red). Sold in carton quantities only.

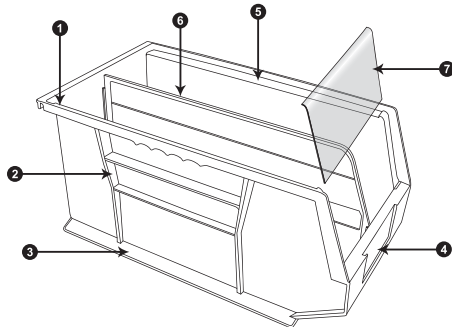

1. Full length hanger
2. Side reinforcing rib design
3. Extra-wide stacking ledge
4. Large front label slots
5. Anti-slid stop to prevent bin shifting
6. Optional Divider
7. Optional see thru window

| Stackable Bins | | | | | |
|------------------------|-----------|------------|-------------|------------|------------|
| Outside D x W x H | Ctn. Qty. | Blue Bins | Yellow Bins | Red Bins | Price Each |
| 5 7/8" x 4 1/8" x 3" | 24 | 225-QTB210 | 225-QTY210 | 225-QTR210 | 1.26 |
| 7 7/8" x 4 1/8" x 3" | 24 | 225-QTB220 | 225-QTY220 | 225-QTR220 | 2.01 |
| 10 7/8" x 5 1/2" x 5" | 12 | 225-QTB230 | 225-QTY230 | 225-QTR230 | 5.25 |
| 10 7/8" x 11" x 5" | 6 | 225-QTB235 | 225-QTY235 | 225-QTR235 | 7.90 |
| 10 3/4" x 8 3/4" x 7" | 6 | 225-QTB239 | 225-QTY239 | 225-QTR239 | 8.44 |
| 14 3/4" x 8 1/2" x 7" | 12 | 225-QTB240 | 225-QTY240 | 225-QTR240 | 10.75 |
| 14 3/4" x 16 1/2" x 7" | 6 | 225-QTB250 | 225-QTY250 | 225-QTR250 | 15.90 |
| 18" x 11" x 10" | 4 | 225-QTB260 | 225-QTY260 | 225-QTR260 | 19.90 |
| 18" x 16 1/2" x 11" | 3 | 225-QTB270 | 225-QTY270 | 225-QTR270 | 26.62 |

| Clear Plastic Windows | | | | |
|-----------------------|-----------|-------------|------------|--|
| Fits Bin | Ctn. Qty. | Blue Bins | Price Each | |
| 225-QTB230 | 12 | 225-QTAW230 | 1.11 | |
| 225-QTB235 | 6 | 225-QTAW235 | 1.58 | |
| 225-QTB239 | 6 | 225-QTAW239 | 1.46 | |
| 225-QTB240 | 12 | 225-QTAW240 | 1.46 | |
| 225-QTB250 | 6 | 225-QTAW250 | 3.20 | |
| 225-QTB260 | 4 | 225-QTAW260 | 2.70 | |
| 225-QTB270 | 3 | 225-QTAW270 | 3.83 | |

| Bin Dividers | | | | |
|--------------|-----------|-------------|------------|--|
| Fits Bin | Ctn. Qty. | Blue Bins | Price Each | |
| 225-QTB210 | 6 | 225-QTAD210 | 0.85 | |
| 225-QTB220 | 6 | 225-QTAD220 | 0.95 | |
| 225-QTB230 | 6 | 225-QTAD230 | 1.46 | |
| 225-QTB235 | 6 | 225-QTAD235 | 1.46 | |
| 225-QTB239 | 6 | 225-QTAD239 | 1.80 | |
| 225-QTB240 | 6 | 225-QTAD240 | 2.48 | |
| 225-QTB250 | 6 | 225-QTAD250 | 2.48 | |
| 225-QTB260 | 6 | 225-QTAD260 | 4.44 | |
| 225-QTB270 | 6 | 225-QTAD270 | 4.76 | |

Plastic Bins

These durable polypropylene bins are designed for either 12", 18" or 24" deep shelving units. Polypropylene bins outlast corrugated and pay for themselves in reduced replacement costs. Bins are waterproof and unaffected by grease and oil. Front of bins have a large label area. Optional bin cups are available and easily fit into all bins. Bin dividers can also be ordered to increase bin functionality by separating small parts and supplies. Sold in carton quantity only.



| Plastic Bins | | | | |
|-------------------|-----------|--------------|------------|--|
| Size W x D x H | Ctn. Qty. | Model Number | Price Each | |
| 4" x 11 1/2" x 4" | 24 | 225-SB124 | 1.63 | |
| 6" x 11 1/2" x 4" | 24 | 225-SB126 | 2.54 | |
| 8" x 11 1/2" x 4" | 24 | 225-SB128 | 2.73 | |
| 4" x 17 1/2" x 4" | 24 | 225-SB184 | 2.19 | |
| 6" x 17 1/2" x 4" | 24 | 225-SB186 | 3.10 | |

Bin Cups



Bin Dividers



| Bin Dividers | | | |
|---------------|-----------|--------------|------------|
| Divider Color | Ctn. Qty. | Model Number | Price Each |
| Black | 24 | 225-SBD4 | 0.40 |
| Black | 24 | 225-SBD6 | 0.46 |
| Black | 24 | 225-SBD8 | 1.00 |

| Bin Cups | | | |
|----------------------|-----------|--------------|------------|
| Outside W x D x H | Ctn. Qty. | Model Number | Price Each |
| 3 1/4" x 1 7/8" x 3" | 100 | 225-SBC1 | 0.43 |

Corrugated Bins

An economical way to store and organize small or loose parts. These rugged bins are constructed of 200 lb. test corrugated board. The bins fold together quickly and are ready for use in seconds. Sold 100 bins per carton only. Priced per bin.



| Size W x D x H | Ctn. Qty. | Model Number | Price Each |
|----------------|-----------|--------------|------------|
| 4" x 12" x 4" | 100 | 225-BC124 | 0.87 |
| 6" x 12" x 4" | 100 | 225-BC126 | 1.01 |
| 8" x 12" x 4" | 100 | 225-BC128 | 1.11 |
| 4" x 18" x 4" | 100 | 225-BC184 | 1.32 |
| 6" x 18" x 4" | 100 | 225-BC186 | 1.42 |

Bin Shelving Units

These handy bin units are great for organizing your small parts. Utilizing the heavy duty construction of our 200A Boltless Shelving system using industrial strength steel components and particle board decking. Available with your choice of plastic or corrugated bins. Units come complete with shelving and bins. Units available with 12" or 18" deep bins.



Advanced Boltless Design



| Bin W x D x H | Unit W x D x H | Bins Per Level | Total # of Bins | Plastic Bin Units | | Corrugated Bin Units | |
|-------------------|-----------------|----------------|-----------------|-------------------|------------|----------------------|------------|
| | | | | Model Number | Price Each | Model Number | Price Each |
| 36"H Units | | | | | | | |
| 4" x 12" x 4" | 36" x 12" x 36" | 8 | 40 | A6-3612-36W-SB4 | 156.84 | A6-3612-36W-CB4 | 126.65 |
| 6" x 12" x 4" | 36" x 12" x 36" | 5 | 25 | A6-3612-36W-SB6 | 155.28 | A6-3612-36W-CB6 | 117.12 |
| 8" x 12" x 4" | 36" x 12" x 36" | 4 | 20 | A6-3612-36W-SB8 | 146.60 | A6-3612-36W-CB8 | 114.23 |
| 4" x 18" x 4" | 36" x 18" x 36" | 8 | 40 | A6-3618-36W-SB4 | 193.63 | A6-3618-36W-CB4 | 158.47 |
| 6" x 18" x 4" | 36" x 18" x 36" | 5 | 25 | A6-3618-36W-SB6 | 183.46 | A6-3618-36W-CB6 | 141.40 |
| 72"H Units | | | | | | | |
| 4" x 12" x 4" | 36" x 12" x 72" | 8 | 88 | A12-3612-72W-SB4 | 312.39 | A12-3612-72W-CB4 | 245.93 |
| 6" x 12" x 4" | 36" x 12" x 72" | 5 | 55 | A12-3612-72W-SB6 | 308.95 | A12-3612-72W-CB6 | 224.98 |
| 8" x 12" x 4" | 36" x 12" x 72" | 4 | 44 | A12-3612-72W-SB8 | 289.87 | A12-3612-72W-CB8 | 218.62 |
| 4" x 18" x 4" | 36" x 18" x 72" | 8 | 88 | A12-3618-72W-SB4 | 387.96 | A12-3618-72W-CB4 | 234.50 |
| 6" x 18" x 4" | 36" x 18" x 72" | 5 | 55 | A12-3618-72W-SB6 | 365.59 | A12-3618-72W-CB6 | 310.56 |
| 4" x 12" x 4" | 36" x 12" x 72" | 8 | 40 | A12-3612-72W-SBC | 310.51 | A12-3612-72W-CBC | 273.01 |
| 6" x 12" x 4" | | 5 | 30 | | | | |
| 4" x 18" x 4" | 36" x 18" x 72" | 8 | 40 | A12-3618-72W-SBC | 375.76 | A12-3618-72W-CBC | 290.08 |
| 6" x 18" x 4" | | 5 | 30 | | | | |

Pick Racks

Pick racks are highly functional and feature angled shelves for easy visibility and quick access to parts and supplies. Available with your choice of plastic or corrugated bins. Units are 12" deep and are available with either 4", 6", or 8" wide bins.

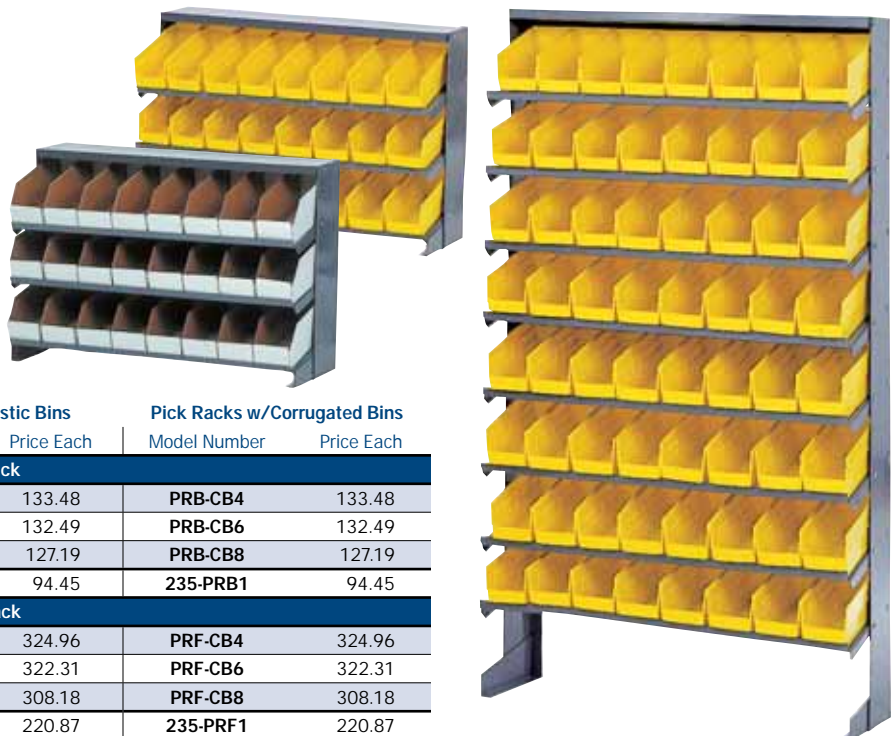

| Bin W x D x H | Total # of Bins | Pick Rack w/Plastic Bins | | Pick Racks w/Corrugated Bins | |
|-------------------|-----------------|--------------------------|------------|------------------------------|------------|
| | | Model Number | Price Each | Model Number | Price Each |
| Bench Rack | | | | | |
| 4" x 12" x 4" | 24 | PRB-SB4 | 133.48 | PRB-CB4 | 133.48 |
| 6" x 12" x 4" | 15 | PRB-SB6 | 132.49 | PRB-CB6 | 132.49 |
| 8" x 12" x 4" | 12 | PRB-SB8 | 127.19 | PRB-CB8 | 127.19 |
| Rack Only | n/a | 235-PRB1 | 94.45 | 235-PRB1 | 94.45 |
| Floor Rack | | | | | |
| 4" x 12" x 4" | 64 | PRF-SB4 | 324.96 | PRF-CB4 | 324.96 |
| 6" x 12" x 4" | 40 | PRF-SB6 | 322.31 | PRF-CB6 | 322.31 |
| 8" x 12" x 4" | 32 | PRF-SB8 | 308.18 | PRF-CB8 | 308.18 |
| Rack Only | n/a | 235-PRF1 | 220.87 | 235-PRF1 | 220.87 |

Heavy Duty Platform Trucks

These durable platform trucks are constructed of heavy gauge steel and are all welded to provide years of dependable service. Deck platform is reinforced to give these rugged trucks incredible strength. All carts now feature a removable handle with two handle cross braces. All platform trucks include 2 swivel (at handle) and 2 rigid casters.



| W x L | Caster Size | Truck Capacity | Model Number | Price Each |
|-----------|-------------|----------------|---------------|------------|
| 24" x 48" | 5" | 600 | PR2448 | 172.22 |
| 27" x 54" | 5" | 600 | PR2754 | 212.15 |
| 30" x 60" | 5" | 600 | PR3060 | 218.39 |
| 36" x 72" | 5" | 600 | PR3672 | 259.57 |
| 24" x 48" | 6" | 1,200 | PS2448 | 204.66 |
| 27" x 54" | 6" | 1,200 | PS2754 | 242.10 |
| 30" x 60" | 6" | 1,200 | PS3060 | 248.34 |
| 36" x 72" | 6" | 1,200 | PS3672 | 288.28 |
| 24" x 48" | 8" | 1,600 | PW2448 | 257.08 |
| 27" x 54" | 8" | 1,600 | PW2754 | 294.52 |
| 30" x 60" | 8" | 1,600 | PW3060 | 299.50 |
| 36" x 72" | 8" | 1,600 | PW3672 | 340.69 |

Platform Trucks with Fold-Down Handle

Versatile platform truck features a fold-down handle for easy storage. Ideal for transporting boxes and light equipment around office or warehouse. Plastic bumpers protect walls, furniture and doorways.



| W x L | Capacity | Model Number | Price Each |
|-----------|----------|-----------------|------------|
| 17" x 27" | 300 | 220-PFD1 | 69.88 |
| 22" x 34" | 500 | 220-PFD2 | 103.58 |

Economy Service Carts

Heavy gauge steel makes our Economy Service Cart superior to most other bolt-together carts on the market. Trays are 3 3/8" deep. Top tray can be reversed to provide platform top. Includes two swivel (locking) and two rigid polypropylene casters. Durable gray powder coated finish. Easy to assemble.



| W x L x H | Capacity | Model Number | Price Each |
|-----------------|----------|--------------------|------------|
| 16" x 30" x 32" | 400 | 220-CSK1630 | 150.07 |

Mobile Workbenches

Save time and money with these handy mobile workbenches. Bench easily rolls on two 5" swivel and two 5" rigid casters. All benches are 36" high and support up to 600 lbs. Steel Color: Powder coated gray.



| 2 Shelf Workbenches | | | 3 Shelf Workbenches | | Extra Shelf | |
|---------------------|---------------------|------------|---------------------|------------|-------------------|------------|
| Shelf W x D | Model Number | Price Each | Model Number | Price Each | Model Number | Price Each |
| 36" x 24" | BC2-3624-30W | 170.73 | BC3-3624-30W | 194.26 | BX1-3624-W | 23.53 |
| 48" x 12" | BC2-4812-30W | 150.76 | BC3-4812-30W | 172.06 | BX1-4812-W | 21.30 |
| 48" x 18" | BC2-4818-30W | 167.90 | BC3-4818-30W | 192.99 | BX1-4818-W | 25.09 |
| 48" x 24" | BC2-4824-30W | 184.35 | BC3-4824-30W | 213.21 | BX1-4824-W | 28.88 |
| 48" x 36" | BC2-4836-30W | 222.53 | BC3-4836-30W | 259.39 | BX1-4836-W | 36.86 |
| 60" x 24" | BC2-6024-30W | 208.89 | BC3-6024-30W | 244.79 | BX1-6024-W | 35.94 |
| 60" x 30" | BC2-6030-30W | 222.76 | BC3-6030-30W | 263.30 | BX1-6030-W | 40.56 |
| 60" x 36" | BC2-6036-30W | 240.32 | BC3-6036-30W | 267.74 | BX1-6036-W | 45.14 |

Stock Racks

235-SRV1 - Vertical Stock Racks - \$230.87

Vertical Stock Racks store long pieces of stock vertically, while smaller sizes are kept on pan shelves. High strength tubular steel arms extend 8" from the frame. Pan shelves are spaced 21" apart. The unit's base is 36" wide x 24" deep. Unit is 84" high and has a capacity of 2,000 lbs.

235-SRH1 - Horizontal Stock Racks - \$230.87

Horizontal Stock Racks can be used individually or in conjunction with other horizontal stock racks, depending on the length of the stock to be stored. These units are 84" high x 22" square at bottom and are tapered to 4 1/2" square at top. Angled steel arms are spaced every 8 1/2" and extend 8" from uprights. Arm capacity 100 lbs. Unit Capacity 1,800 lbs.



Vertical Stock Racks



Horizontal Stock Racks

FastRak Tire Storage Shelving

FastRak unit design makes these extra heavy duty units perfect for storing today's larger tires. Recommended for tires that accommodate 16" and larger rims. 48"W , 72"W and 96"W units accommodate 6, 9 and 12 tires (estimated) per level respectively. All units are 18" deep. Units feature a newly designed upright that can be "knocked down" for easier shipment. Uprights can be shipped pre-assembled for an additional charge per upright. Optional deluxe footplates and concrete wedge anchors are available for added safety and permanent placement.

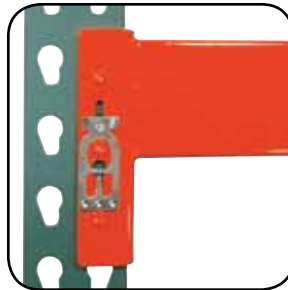

| W x D x H | # of Levels | Starter Units | | Add-On Units | |
|------------------|-------------|---------------|------------|--------------|------------|
| | | Model Number | Price Each | Model Number | Price Each |
| 48" x 18" x 96" | 3 | K33S-4818096 | 209.12 | K33T-4818096 | 156.88 |
| 48" x 18" x 120" | 4 | K34S-4818120 | 269.96 | K34T-4818120 | 204.74 |
| 72" x 18" x 96" | 3 | K33S-7218096 | 256.16 | K33T-7218096 | 203.93 |
| 72" x 18" x 120" | 4 | K34S-7218120 | 332.68 | K34T-7218120 | 267.46 |
| 96" x 18" x 96" | 3 | K33S-9618096 | 303.32 | K33T-9618096 | 251.08 |
| 96" x 18" x 120" | 4 | K34S-9618120 | 395.56 | K34T-9618120 | 330.34 |

FastRak Cable Reel Racks

Based on the popular FastRak Bulk Storage Shelving, these rugged reel racks are super strong and highly versatile. Heavy duty uprights are completely welded. Beams attach quickly to uprights using popular "tear drop" design and can be adjusted in 1 1/2" increments. Beams also feature a built-in locking clip for added safety. Free standing "Starter" units include 2 uprights, 3 beams and 3 rods (36" tall units include 2 rods). Create a row of rack by purchasing "Add-On" units. Customize your rack by purchasing additional rods (1 per level) and brackets (2 brackets are required per level). 1" diameter rods can support up to 350 lbs. per level. Unit capacity: 6,000 lbs.

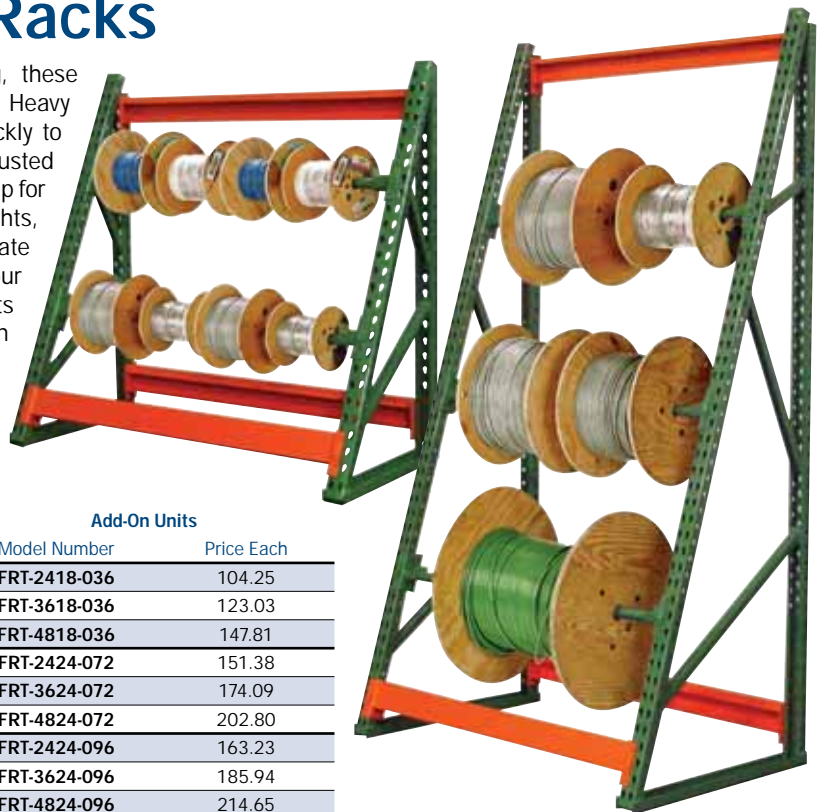

| W x D x H | Starter Units | | Add-On Units | |
|------------------|---------------|------------|--------------|------------|
| | Model Number | Price Each | Model Number | Price Each |
| 24" x 18" x 36" | FRS-2418-036 | 131.90 | FRT-2418-036 | 104.25 |
| 36" x 18" x 36" | FRS-3618-036 | 150.68 | FRT-3618-036 | 123.03 |
| 48" x 18" x 36" | FRS-4818-036 | 175.46 | FRT-4818-036 | 147.81 |
| 24" x 24" x 72" | FRS-2424-072 | 200.10 | FRT-2424-072 | 151.38 |
| 36" x 24" x 72" | FRS-3624-072 | 222.81 | FRT-3624-072 | 174.09 |
| 48" x 24" x 72" | FRS-4824-072 | 251.52 | FRT-4824-072 | 202.80 |
| 24" x 24" x 96" | FRS-2424-096 | 223.80 | FRT-2424-096 | 163.23 |
| 36" x 24" x 96" | FRS-3624-096 | 246.51 | FRT-3624-096 | 185.94 |
| 48" x 24" x 96" | FRS-4824-096 | 275.22 | FRT-4824-096 | 214.65 |
| 24" x 36" x 96" | FRS-2436-096 | 239.60 | FRT-2436-096 | 171.13 |
| 36" x 36" x 96" | FRS-3636-096 | 262.31 | FRT-3636-096 | 193.84 |
| 48" x 36" x 96" | FRS-4836-096 | 291.02 | FRT-4836-096 | 222.55 |
| 24" x 24" x 120" | FRS-2424-120 | 244.76 | FRT-2424-120 | 173.71 |
| 36" x 24" x 120" | FRS-3624-120 | 267.47 | FRT-3624-120 | 196.42 |
| 48" x 24" x 120" | FRS-4824-120 | 296.18 | FRT-4824-120 | 225.13 |
| 24" x 36" x 120" | FRS-2436-120 | 265.92 | FRT-2436-120 | 184.29 |
| 36" x 36" x 120" | FRS-3636-120 | 288.63 | FRT-3636-120 | 207.00 |
| 48" x 36" x 120" | FRS-4836-120 | 317.34 | FRT-4836-120 | 235.71 |

| Description | Model Number | Price Each |
|-----------------------|--------------|------------|
| Extra Rods | | |
| 24" Bar (1" Dia.) | 215-CR01024 | 7.86 |
| 36" Bar (1" Dia.) | 215-CR01036 | 11.79 |
| 48" Bar (1" Dia.) | 215-CR01048 | 15.72 |
| Extra Brackets | | |
| Bar Bracket (left) | 215-CRBL01 | 9.10 |
| Bar Bracket (right) | 215-CRBR01 | 9.10 |



CANTILEVER RACK

pages 22-23

Catalog Version: 0909-DC

ARCHIVE SHELVING

page 12



WORKBENCHES

pages 24-25



PLATFORM TRUCKS & SERVICE CARTS

page 30



STACKABLE BINS

page 28

PALLET RACK

pages 18-21

