

# STACKABLE BINS & SHELVING

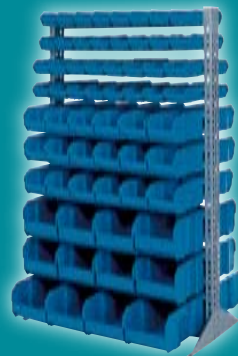

# STACKABLE BINS

These stackable bins are made of heavy duty polypropylene with permanent molded-in color. They are virtually unbreakable and are water, rust and corrosion-proof. Ideal for assembly, production, manufacturing or repair areas. Finger grips are provided for ease of handling. Bin fronts have a large slotted label area. Bins have reinforced ribs to prevent them from spreading under load. Clear plastic windows are available to increase bin storage capacity while maintaining easy visibility of bin content. Enhance bin functionality by adding optional bin dividers. Choose from 9 different sizes and 3 different colors (blue, yellow and red.)

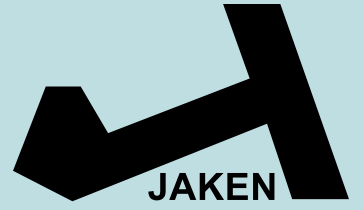
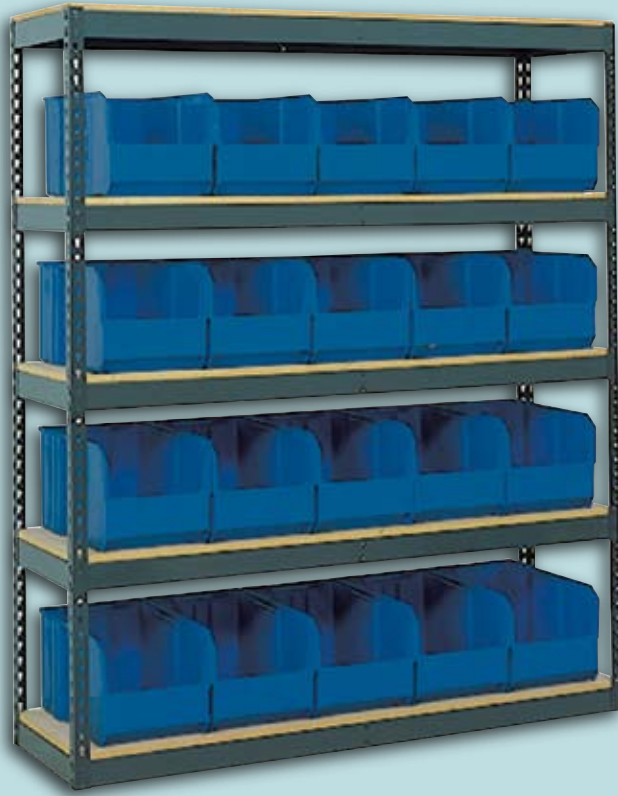

Outside D x W x H	*Ctn Qty	Blue Bins	Yellow Bins	Red Bins
5 <sup>3</sup> / <sub>8</sub> " x 4 <sup>1</sup> / <sub>8</sub> " x 3"	24	225-QTB210	225-QTY210	225-QTR210
7 <sup>3</sup> / <sub>8</sub> " x 4 <sup>1</sup> / <sub>8</sub> " x 3"	24	225-QTB220	225-QTY220	225-QTR220
10 <sup>7</sup> / <sub>8</sub> " x 5 <sup>1</sup> / <sub>2</sub> " x 5"	12	225-QTB230	225-QTY230	225-QTR230
10 <sup>7</sup> / <sub>8</sub> " x 11" x 5"	6	225-QTB235	225-QTY235	225-QTR235
10 <sup>3</sup> / <sub>4</sub> " x 8 <sup>1</sup> / <sub>4</sub> " x 7"	6	225-QTB239	225-QTY239	225-QTR239
14 <sup>3</sup> / <sub>4</sub> " x 8 <sup>1</sup> / <sub>2</sub> " x 7"	12	225-QTB240	225-QTY240	225-QTR240
14 <sup>3</sup> / <sub>4</sub> " x 16 <sup>1</sup> / <sub>2</sub> " x 7"	6	225-QTB250	225-QTY250	225-QTR250
18" x 11" x 10"	4	225-QTB260	225-QTY260	225-QTR260
18" x 16 <sup>1</sup> / <sub>2</sub> " x 11"	3	225-QTB270	225-QTY270	225-QTR270

Clear Plastic Windows		
Fits Bin	*Ctn Qty	Model Number
225-QT(B/Y/R)210	N/A	N/A
225-QT(B/Y/R)220	N/A	N/A
225-QT(B/Y/R)230	12	225-QTAW230
225-QT(B/Y/R)235	6	225-QTAW235
225-QT(B/Y/R)239	6	225-QTAW239
225-QT(B/Y/R)240	12	225-QTAW240
225-QT(B/Y/R)250	6	225-QTAW250
225-QT(B/Y/R)260	4	225-QTAW260
225-QT(B/Y/R)270	3	225-QTAW270

Bin Dividers		
Fits Bin	*Pkg Qty	Model Number
225-QT(B/Y/R)210	6	225-QTAD210
225-QT(B/Y/R)220	6	225-QTAD220
225-QT(B/Y/R)230	6	225-QTAD230
225-QT(B/Y/R)235	6	225-QTAD235
225-QT(B/Y/R)239	6	225-QTAD239
225-QT(B/Y/R)240	6	225-QTAD240
225-QT(B/Y/R)250	6	225-QTAD250
225-QT(B/Y/R)260	6	225-QTAD260
225-QT(B/Y/R)270	6	225-QTAD270

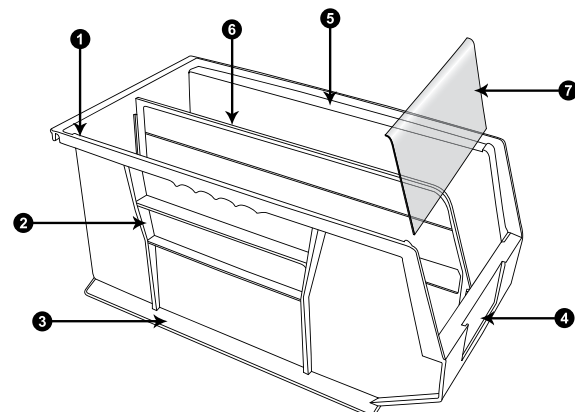

1. Full length Hanger
2. Side reinforcing rib design
3. Extra-wide stacking ledge
4. Large front label slots
5. Anti-slid stop to prevent bin shifting
6. Optional Divider
7. Optional see thru window

**\*Sold in carton quantities only.**

# JUMBO BIN STORAGE UNITS

Jumbo bin storage units come complete with bins. Bins are made of heavy duty polypropylene and are unaffected by water, grease and oil. Shelving features heavy duty industrial boltless design which provides for quick, easy assembly and years of dependable service. These units are a cost effective and efficient way to store small, medium and large parts. Bins are rust and corrosion-proof. When placing an order use (B) "Blue," (Y) "Yellow," and (R) "Red" to indicate bin color selection.



Series 200B Units

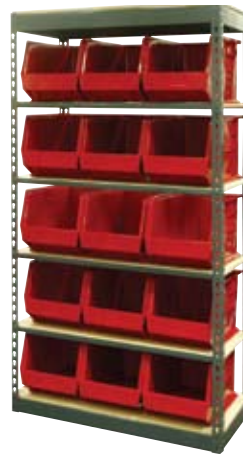

Series 200A Units



Mobile Units

Series 200A Units with Bins			
W x D x H	# of Bins	# of Shelves	Model Number
36" x 18" x 36"	6	3	QK1-(B/Y/R)260
48" x 18" x 36"	8	3	QK2-(B/Y/R)260
36" x 18" x 72"	15	6	QL1-(B/Y/R)260
48" x 18" x 72"	20	6	QL2-(B/Y/R)260

Series 200B Units with Bins			
W x D x H	# of Bins	# of Shelves	Model Number
36" x 18" x 67"	12	5	QP1-(B/Y/R)260
48" x 18" x 67"	16	5	QP2-(B/Y/R)260
60" x 18" x 67"	20	5	QP3-(B/Y/R)260
72" x 18" x 72"	24	5	QP4-(B/Y/R)260
96" x 18" x 72"	32	5	QP5-(B/Y/R)260

Mobile Units with Bins			
W x D x H	# of Bins	# of Shelves	Model Number
48" x 18" x 67"	16	5	QM2-(B/Y/R)260
60" x 18" x 67"	20	5	QM3-(B/Y/R)260
48" x 36" x 67"	32	5	QM7-(B/Y/R)260
60" x 36" x 67"	40	5	QM8-(B/Y/R)260

# FREE-STANDING BIN STORAGE UNITS

Provides quick and easy access to small and medium parts. Bins can be easily removed from storage units for transport to work areas. Durable polypropylene bins are virtually crack and chip proof. Ideal for use in assembly/production areas. All units are 36" wide and are available as 30" tall Bench Units or 60" tall Floor Units. Floor Units are available in either single-sided or double-sided configurations. Easy to assemble. No special tools required. 750 lbs. total unit capacity. Bins included. When placing an order use (B) "Blue," (Y) "Yellow," and (R) "Red" to indicate bin color selection.

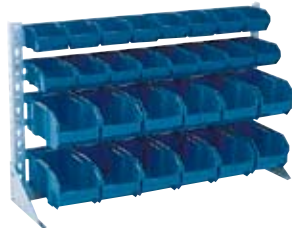

Bench Rack - 36"W x 30"H				
Bin D x W x H	# of Rows	Bins/Row	# of Bins	Model Number
5 <sup>3</sup> / <sub>8</sub> " x 4 <sup>1</sup> / <sub>8</sub> " x 3"	5	8	40	QE(B/Y/R)210
7 <sup>3</sup> / <sub>8</sub> " x 4 <sup>1</sup> / <sub>8</sub> " x 3"	5	8	40	QE(B/Y/R)220
10 <sup>7</sup> / <sub>8</sub> " x 5 <sup>1</sup> / <sub>2</sub> " x 5"	4	6	24	QE(B/Y/R)230
10 <sup>7</sup> / <sub>8</sub> " x 11" x 5"	4	3	12	QE(B/Y/R)235
10 <sup>3</sup> / <sub>4</sub> " x 8 <sup>1</sup> / <sub>4</sub> " x 7"	3	4	12	QE(B/Y/R)239
5 <sup>3</sup> / <sub>8</sub> " x 4 <sup>1</sup> / <sub>8</sub> " x 3"	1	8	8	QE(B/Y/R)C1 4 total rows
7 <sup>3</sup> / <sub>8</sub> " x 4 <sup>1</sup> / <sub>8</sub> " x 3"	1	8	8	
10 <sup>7</sup> / <sub>8</sub> " x 5 <sup>1</sup> / <sub>2</sub> " x 5"	2	6	12	
10 <sup>7</sup> / <sub>8</sub> " x 5 <sup>1</sup> / <sub>2</sub> " x 5"	2	6	12	

Single Sided Floor Rack - 36"W x 60"H				
Bin D x W x H	# of Rows	Bins/Row	# of Bins	Model Number
5 <sup>3</sup> / <sub>8</sub> " x 4 <sup>1</sup> / <sub>8</sub> " x 3"	12	8	96	QF(B/Y/R)210
7 <sup>3</sup> / <sub>8</sub> " x 4 <sup>1</sup> / <sub>8</sub> " x 3"	12	8	96	QF(B/Y/R)220
10 <sup>7</sup> / <sub>8</sub> " x 5 <sup>1</sup> / <sub>2</sub> " x 5"	9	6	54	QF(B/Y/R)230
10 <sup>7</sup> / <sub>8</sub> " x 11" x 5"	9	3	27	QF(B/Y/R)235
10 <sup>3</sup> / <sub>4</sub> " x 8 <sup>1</sup> / <sub>4</sub> " x 7"	7	4	28	QF(B/Y/R)239
14 <sup>3</sup> / <sub>4</sub> " x 8 <sup>1</sup> / <sub>2</sub> " x 7"	7	4	28	QF(B/Y/R)240
14 <sup>3</sup> / <sub>4</sub> " x 16 <sup>1</sup> / <sub>2</sub> " x 7"	7	2	14	QF(B/Y/R)250
5 <sup>3</sup> / <sub>8</sub> " x 4 <sup>1</sup> / <sub>8</sub> " x 3"	2	8	16	QF(B/Y/R)C1 4 10 total rows
7 <sup>3</sup> / <sub>8</sub> " x 4 <sup>1</sup> / <sub>8</sub> " x 3"	2	8	16	
10 <sup>7</sup> / <sub>8</sub> " x 5 <sup>1</sup> / <sub>2</sub> " x 5"	3	6	18	
10 <sup>3</sup> / <sub>4</sub> " x 8 <sup>1</sup> / <sub>4</sub> " x 7"	2	4	8	
14 <sup>3</sup> / <sub>4</sub> " x 8 <sup>1</sup> / <sub>2</sub> " x 7"	1	4	4	

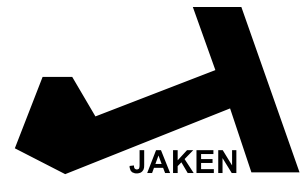

**Boltless Shelving**



**Pallet Rack**



**Cantilever Rack**



**FastRak Bulk Shelving**



**Wire Shelving**



**Archive Shelving**



**Workbenches & Packing Tables**



**Carts & Trucks**

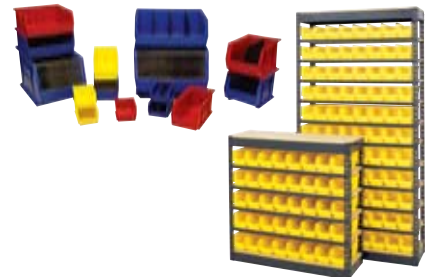

**Bins & Boxes**

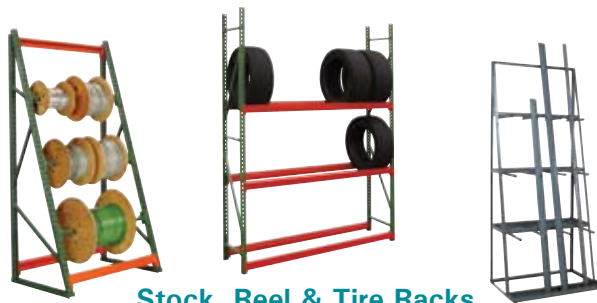

**Stock, Reel & Tire Racks**

For more information, please contact the approved dealer or distributor below.

**Distributed By:**